

***chcoze***

# P1201 Series

## User Manual



### **A SLIM AND POWER EFFICIENT COMPUTER**

Intel® Elkhart Lake Atom® x6000E Series Processor Slim Embedded Computer with CDS Technology

Version: V1.01

# Contents

Preface .....	4
Revision .....	4
Copyright Notice .....	4
Acknowledgement .....	4
Disclaimer.....	4
Declaration of Conformity.....	4
Product Warranty Statement .....	5
Technical Support and Assistance .....	6
Conventions Used in this Manual .....	7
Safety Precautions.....	7
Package Checklist .....	9
Ordering Information .....	9
Chapter 1 Product Introductions .....	10
1.1 Overview .....	11
1.2 Highlights.....	11
1.3 Product Pictures.....	12
1.4 Key Features.....	13
1.5 Hardware Specification .....	14
1.6 System I/O.....	17
1.6.1 Front.....	17
1.6.2 Rear .....	18
1.6.3 Right.....	19
1.6.4 Left .....	19
1.6.5 Top.....	20
1.7 Mechanical Dimension.....	21
Chapter 2 Switches & Connectors.....	22
2.1 Location of Switches and Connectors .....	23
2.1.1 Top View.....	23
2.1.2 Bottom View .....	24
2.2 Switches and Connectors Definition .....	25
2.3 Definition of Switches .....	26
2.4 Definition of Connectors .....	28
Chapter 3 System Setup .....	32
3.1 Removing Top Cover.....	33
3.2 Installing SO-DIMM Memory .....	34
3.3 Installing Mini-PCIe Card .....	35
3.4 Installing M.2 E Key Card.....	36
3.5 Installing Antenna(s) .....	37
3.6 Installing CPU Thermal Pad .....	39

3.7 Installing Top Cover .....	40
3.8 Installing SATA Hard Drive .....	41
3.9 Installing SIM Card .....	43
3.10 Installing Wall Mount .....	44
3.11 Installing DIN-Rail Mount .....	46
3.12 Installing VESA Mount .....	47
3.13 Connecting with Display Module .....	48
Chapter 4 BIOS Setup .....	50
4.1 BIOS Introduction .....	51
4.2 Main Setup .....	52
4.3 Advanced Setup .....	53
4.3.1 CPU Configuration .....	53
4.3.2 SATA Configuration .....	54
4.3.3 PCH-FW Configuration .....	54
4.3.4 Trusted Computing Settings .....	55
4.3.5 ACPI Settings .....	56
4.3.6 F81966 Super IO Configuration .....	56
4.3.7 Hardware Monitor .....	58
4.3.8 S5 RTC Wake Settings .....	58
4.3.9 Serial Port Console Redirection .....	59
4.3.10 USB Configuration .....	59
4.3.11 Network Stack Configuration .....	60
4.4 Chipset Setup .....	61
4.4.1 System Agent (SA) Configuration .....	61
4.4.2 PCH-IO Configuration .....	62
4.5 Security Setup .....	64
4.6 Boot Setup .....	65
4.7 Save & Exit .....	66
Chapter 5 Product Application .....	67
5.1 Digital I/O (DIO) application .....	68
5.1.1 Digital I/O Programming Guide .....	68
5.2 Digital I/O (DIO) Hardware Specification .....	75
5.2.1 DIO Connector Definition .....	75
Chapter 6 Optional Modules and Accessories .....	77
6.1 Pin Definition & Settings .....	78
6.1.1 CFM-IGN101 .....	78
6.2 Installing CFM Module .....	79
6.2.1 CFM-IGN101 .....	79
6.2.2 CFM-PoE02 .....	80

# Preface

## Revision

Revision	Description	Date
1.00	First Release	2023/03/24
1.01	Correction Made	2023/05/04

## Copyright Notice

© 2023 by Cincoze Co., Ltd. All rights are reserved. No parts of this manual may be copied, modified, or reproduced in any form or by any means for commercial use without the prior written permission of Cincoze Co., Ltd. All information and specification provided in this manual are for reference only and remain subject to change without prior notice.

## Acknowledgement

Cincoze is a registered trademark of Cincoze Co., Ltd. All registered trademarks and product names mentioned herein are used for identification purposes only and may be trademarks and/or registered trademarks of their respective owners.

## Disclaimer

This manual is intended to be used as a practical and informative guide only and is subject to change without notice. It does not represent a commitment on the part of Cincoze. This product might include unintentional technical or typographical errors. Changes are periodically made to the information herein to correct such errors, and these changes are incorporated into new editions of the publication.

## Declaration of Conformity



### FCC

This equipment has been tested and found to comply with the limits for a Class A digital device, pursuant to Part 15 of the FCC Rules. These limits are designed to provide reasonable protection against harmful interference when the equipment is operated in a commercial environment. This equipment generates, uses, and can radiate radio frequency energy and, if not installed and used in accordance with the

instruction manual, may cause harmful interference to radio communications. Operation of this equipment in a residential area is likely to cause harmful interference in which case the user will be required to correct the interference at his own expense.



#### CE

The product(s) described in this manual complies with all application European Union (CE) directives if it has a CE marking. For computer systems to remain CE compliant, only CE-compliant parts may be used. Maintaining CE compliance also requires proper cable and cabling techniques.



#### UL

A product that carries the “UL Listed” approval mark means that the product has been tested by UL to nationally recognized Safety Standards and has been found to be free from reasonably foreseeable risk of fire, electric shock and related hazards

## Product Warranty Statement

### Warranty

Cincoze products are warranted by Cincoze Co., Ltd. to be free from defect in materials and workmanship for 2 years from the date of purchase by the original purchaser. During the warranty period, we shall, at our option, either repair or replace any product that proves to be defective under normal operation. Defects, malfunctions, or failures of the warranted product caused by damage resulting from natural disasters (such as by lightning, flood, earthquake, etc.), environmental and atmospheric disturbances, other external forces such as power line disturbances, plugging the board in under power, or incorrect cabling, and damage caused by misuse, abuse, and unauthorized alteration or repair, and the product in question is either software, or an expendable item (such as a fuse, battery, etc.), are not warranted.

### RMA

Before sending your product in, you will need to fill in Cincoze RMA Request Form and obtain an RMA number from us. Our staff is available at any time to provide you with the most friendly and immediate service.

#### ■ RMA Instruction

- Customers must fill in Cincoze Return Merchandise Authorization (RMA) Request Form and obtain an RMA number prior to returning a defective product to Cincoze for service.
- Customers must collect all the information about the problems encountered and note anything abnormal and describe the problems on the “Cincoze Service Form” for the RMA number apply process.
- Charges may be incurred for certain repairs. Cincoze will charge for repairs to products whose warranty period has expired. Cincoze will also charge for repairs to

products if the damage resulted from acts of God, environmental or atmospheric disturbances, or other external forces through misuse, abuse, or unauthorized alteration or repair. If charges will be incurred for a repair, Cincoze lists all charges, and will wait for customer's approval before performing the repair.

- Customers agree to ensure the product or assume the risk of loss or damage during transit, to prepay shipping charges, and to use the original shipping container or equivalent.
- Customers can be sent back the faulty products with or without accessories (manuals, cable, etc.) and any components from the system. If the components were suspected as part of the problems, please note clearly which components are included. Otherwise, Cincoze is not responsible for the devices/parts.
- Repaired items will be shipped along with a "Repair Report" detailing the findings and actions taken.

### **Limitation of Liability**

Cincoze' liability arising out of the manufacture, sale, or supplying of the product and its use, whether based on warranty, contract, negligence, product liability, or otherwise, shall not exceed the original selling price of the product. The remedies provided herein are the customer's sole and exclusive remedies. In no event shall Cincoze be liable for direct, indirect, special or consequential damages whether based on contract of any other legal theory.

### **Technical Support and Assistance**

1. Visit the Cincoze website at [www.cincoze.com](http://www.cincoze.com) where you can find the latest information about the product.
2. Contact your distributor or our technical support team or sales representative for technical support if you need additional assistance. Please have following information ready before you call:
  - Product name and serial number
  - Description of your peripheral attachments
  - Description of your software (operating system, version, application software, etc.)
  - A complete description of the problem
  - The exact wording of any error messages

## Conventions Used in this Manual



**WARNING**  
(AVERTIR)

This indication alerts operators to an operation that, if not strictly observed, may result in severe injury.

(Cette indication avertit les opérateurs d'une opération qui, si elle n'est pas strictement observée, peut entraîner des blessures graves.)



**CAUTION**  
(ATTENTION)

This indication alerts operators to an operation that, if not strictly observed, may result in safety hazards to personnel or damage to equipment.

(Cette indication avertit les opérateurs d'une opération qui, si elle n'est pas strictement observée, peut entraîner des risques pour la sécurité du personnel ou des dommages à l'équipement.)



**NOTE**

This indication provides additional information to complete a task easily.

## Safety Precautions

Before installing and using this device, please note the following precautions.

1. Read these safety instructions carefully.
2. Keep this User's Manual for future reference.
3. Disconnect this equipment from any AC outlet before cleaning.
4. For plug-in equipment, the power outlet socket must be located near the equipment and must be easily accessible.
5. Keep this equipment away from humidity.
6. Put this equipment on a reliable surface during installation. Dropping it or letting it fall may cause damage.
7. Make sure the voltage of the power source is correct before connecting the equipment to the power outlet.
8. Use a power cord that has been approved for using with the product and that it matches the voltage and current marked on the product's electrical range label. The voltage and current rating of the cord must be greater than the voltage and current rating marked on the product.
9. Position the power cord so that people cannot step on it. Do not place anything over the power cord.
10. All cautions and warnings on the equipment should be noted.
11. If the equipment is not used for a long time, disconnect it from the power source to avoid damage by transient overvoltage.
12. Never pour any liquid into an opening. This may cause fire or electrical shock.

13. Never open the equipment. For safety reasons, the equipment should be opened only by qualified service personnel.

If one of the following situations arises, get the equipment checked by service personnel:

- The power cord or plug is damaged.
- Liquid has penetrated into the equipment.
- The equipment has been exposed to moisture.
- The equipment does not work well, or you cannot get it work according to the user's manual.
- The equipment has been dropped and damaged.
- The equipment has obvious signs of breakage.

14. CAUTION: Risk of Explosion if Battery is replaced by an Incorrect Type. Dispose of Used Batteries According to the Instructions.

ATTENTION: Risque d'explosion si la batterie est remplacée par un type incorrect. Mettre au rebut les batteries usagées selon les instructions.

15. Equipment intended only for use in a RESTRICTED ACCESS AREA.
16. Output of the external power source shall be complied with ES1, PS3 requirements, output rating between 9-48 VDC, minimum 6-1.5A, with minimum rated maximum ambient temperature 70°C, and has to be evaluated according to UL/IEC/EN 60950-1 and/or UL/IEC/EN 62368-1. If need further assistance, please contact Cincoze for further information.
17. Ensure to connect the power cord of power adapter to a socket-outlet with earthing connection.



## Package Checklist

Before installation, please ensure all the items listed in the following table are included in the package.

Item	Description	Q'ty
1	P1201 Slim Embedded System	1
2	Thermal Pad (for CPU Thermal Block)	1
3	Wall Mounting Kit	1
4	Screw Pack	1
5	Power Terminal Block Connector	1
6	Remote Function Terminal Block Connector	1
7	DIN Rail Mounting Kit	1
8	DIO Terminal Block Connector	1

Note: *Notify your sales representative if any of the above items are missing or damaged.*

## Ordering Information

Model No.	Description
P1201-X6425E-R10	Intel® Atom® x6425E Quad Core Slim Embedded Computer with CDS Technology
P1201-X6211E-R10	Intel® Atom® x6211E Dual Core Slim Embedded Computer with CDS Technology



# **Chapter 1**

## **Product Introductions**

# 1.1 Overview

The P1201 is an Intel® Elkhart Lake Atom® processor-equipped, ultra-thin, fanless embedded computer for IoT edge computing. It offers flexible expansion with a rich assortment of native I/O ports, Mini PCIe and M.2 Key E Type 2230 slots, and an exclusive CFM slot to add functions such as PoE or IGN. The chassis measures only 41.5 mm, making it suitable for installation in narrow space-limited applications.

“One computer / Two purposes” is the P1201’s crowning feature. The patented Convertible Display System (CDS) enables the addition of one of a selection of display modules to convert the P1201 from an embedded computer to an industrial panel PC, sunlight-readable panel PC, or open-frame panel PC, satisfying diverse display computing needs.

# 1.2 Highlights

## Next-gen Performance

The P1201 supports up to an Intel® Atom® x6425E (Elkhart Lake) 4-core processor, with 1.7 times the single-thread performance, 1.5 times the multi-thread performance, and double the graphics performance of the previous-generation Apollo Lake processor. Up to 32 GB of 3200 MHz DDR4 is supported.

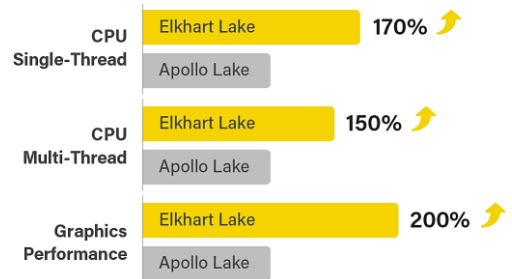

## Ultra-thin Chassis and Easy Installation

The P1201 has an ultra-thin and compact design, only 204.5 × 149 × 41.5 (mm), enabling smart factories to collect and process data in space-limited applications such as equipment machines, control cabinets, AGVs, and more.

## One Computer / Two Purposes

The P1201 is an embedded computer that can become a panel PC using Cincoze’s patented Convertible Display System (CDS) interface to attach an industrial display module (CV-100 series), sunlight-readable display module (CS-100 series), or open-frame display module (CO-100 series) to create a panel PC with specific characteristics.

Patent No. M482908





## Full Wireless Connectivity

The P1201 supports all the wireless transmission methods required for mobile devices, including an M.2 Key E module with high-speed WiFi 6 for fast data transfer and Bluetooth for peripheral connections, and a GPS and 4G Mini PCIe module. These options cover most wireless transmission needs.

## Vibration Resistance and Industrial EMC Protection

The P1201 is vibration resistant and incorporates EMC protections to ensure stable and continuous operation in equipment, control cabinets, and mobile equipment. The P1201 passes various vibration and shock reliability tests, including random vibration (5G), sinusoidal vibration (1.5G), and shock resistance (50G), meeting the harsh industrial EMC testing standards (EN 61000-6-4 and EN 61000-6-2), UL certification product safety standard, and high-standard industrial-grade protections.



## 1.3 Product Pictures



Right / Front



Left / Rear

## 1.4 Key Features

- Intel® Elkhart Lake Atom® x6425E/x6211E Processor
- 1x DDR4 SO-DIMM
- 1x M.2 Key E Type 2230 Socket for Wireless Module
- CFM Technology for Power Ignition Sensing Function and PoE Function
- Cincoze Patent CDS Technology Support (Patent No. M482908)
- EMC Emission / Immunity Standard for Industrial Environment: EN61000-6-4, EN61000-6-2
- Safety Certification: UL, cUL, CB 62368-1

# 1.5 Hardware Specification

<b>System</b>	
Processor	<ul style="list-style-type: none"> <li>• Intel® Atom® x6425E Processor (1.5M Cache, up to 3.00 GHz, 12W)</li> <li>• Intel® Atom® x6211E Processor (1.5M Cache, up to 3.00 GHz, 6W)</li> </ul>
Memory	<ul style="list-style-type: none"> <li>• 1x DDR4 SO-DIMM Socket</li> <li>• Supports DDR4 3200MHz Memory Up to 32GB (un-buffered and non-ECC)</li> </ul>
BIOS	<ul style="list-style-type: none"> <li>• AMI BIOS</li> </ul>
<b>Graphics</b>	
Graphics Engine	<ul style="list-style-type: none"> <li>• Integrated Intel® UHD Graphics</li> </ul>
Maximum Display Output	<ul style="list-style-type: none"> <li>• Supports Triple Independent Display</li> </ul>
CDS	<ul style="list-style-type: none"> <li>• 1x CDS Connector (1920 x 1080 @ 60Hz)</li> </ul>
DP	<ul style="list-style-type: none"> <li>• 1x DisplayPort Connector (4096 x 2304 @ 60Hz, According to CPU Specifications)</li> <li>* Verified maximum resolution: 3840x2160 @ 60Hz</li> </ul>
VGA	<ul style="list-style-type: none"> <li>• 1x VGA Connector (1920 x 1200 @60Hz)</li> </ul>
<b>Audio</b>	
Audio Codec	<ul style="list-style-type: none"> <li>• Realtek® ALC888, High Definition Audio</li> </ul>
Line-out	<ul style="list-style-type: none"> <li>• 1x Line-out, Phone Jack 3.5mm</li> </ul>
Mic-in	<ul style="list-style-type: none"> <li>• 1x Mic-in, Phone Jack 3.5mm</li> </ul>
<b>I/O</b>	
LAN	<ul style="list-style-type: none"> <li>• 2x GbE LAN, RJ45</li> <li>- GbE1: Intel® I210</li> <li>- GbE2: Intel® I210</li> </ul>
COM	<ul style="list-style-type: none"> <li>• 3x RS-232/422/485 with Auto Flow Control, DB9</li> </ul>
USB	<ul style="list-style-type: none"> <li>• 3x 10Gbps USB 3.2 Gen2, Type A</li> <li>• 1x 480Mbps USB 2.0, Type A</li> </ul>
DIO	<ul style="list-style-type: none"> <li>• 8x Isolated DIO (4x DI/4x DO), 10-Pin Terminal Block</li> </ul>
<b>Storage</b>	
SSD/HDD	<ul style="list-style-type: none"> <li>• 1x 2.5" Front Accessible SATA HDD/SSD Drive Bay (SATA 3.0)</li> </ul>
mSATA	<ul style="list-style-type: none"> <li>• 1x mSATA Socket (SATA 3.0, shared by Mini-PCIe socket)</li> </ul>

<b>Expansion</b>	
Mini PCI Express	<ul style="list-style-type: none"> <li>• 1x Full-size Mini-PCIe Socket</li> </ul>
SIM Socket	<ul style="list-style-type: none"> <li>• 1x SIM Socket</li> </ul>
M.2	<ul style="list-style-type: none"> <li>• 1x M.2 Key E 2230 Socket, Support Wireless Module</li> </ul>
CFM (Control Function Module) Interface	<ul style="list-style-type: none"> <li>• 1x CFM IGN Interface for optional CFM-IGN Module Expansion</li> <li>• 1x CFM PoE Interface for optional CFM-PoE Module Expansion</li> </ul>
CDS (Convertible Display System) Interface	<ul style="list-style-type: none"> <li>• 1x CDS Interface for Convertible Display Module</li> </ul>
<b>Other Function</b>	
Clear CMOS Switch	<ul style="list-style-type: none"> <li>• 1x Clear CMOS Switch</li> </ul>
Reset Button	<ul style="list-style-type: none"> <li>• 1x Reset Button</li> </ul>
Instant Reboot	<ul style="list-style-type: none"> <li>• Support 0.2sec Instant Reboot Technology</li> </ul>
Watchdog Timer	<ul style="list-style-type: none"> <li>• Software Programmable Supports 256 Levels System Reset</li> </ul>
OSD Button	<ul style="list-style-type: none"> <li>• LCD On/Off, Brightness Up, Brightness Down</li> </ul>
Internal Speaker	<ul style="list-style-type: none"> <li>• AMP 2W + 2W</li> </ul>
Status LED Indicator	<ul style="list-style-type: none"> <li>• Power LED, HDD LED, Temperature LED</li> </ul>
<b>Power</b>	
Power Button	<ul style="list-style-type: none"> <li>• 1x ATX Power On/Off Button</li> </ul>
Power Mode Switch	<ul style="list-style-type: none"> <li>• 1x AT/ATX Mode Switch</li> </ul>
Power Input	<ul style="list-style-type: none"> <li>• 9-48VDC, 3-pin Terminal Block</li> </ul>
Remote Power On/Off	<ul style="list-style-type: none"> <li>• 1x Remote Power On/Off, 2-pin Terminal Block</li> </ul>
Remote Power LED	<ul style="list-style-type: none"> <li>• 1x Remote Power LED, 2-pin Terminal Block</li> </ul>
<b>Operating System</b>	
Windows	<ul style="list-style-type: none"> <li>• Windows® 10</li> </ul>
Linux	<ul style="list-style-type: none"> <li>• Supports by project</li> </ul>
<b>Physical</b>	
Dimension (W x D x H)	<ul style="list-style-type: none"> <li>• 204.5 x 149 x 41.5 mm</li> </ul>
Weight Information	<ul style="list-style-type: none"> <li>• 1.54 KG</li> </ul>
Mechanical Construction	<ul style="list-style-type: none"> <li>• Extruded Aluminum with Heavy Duty Metal</li> </ul>

Mounting	<ul style="list-style-type: none"> <li>• Wall/ VESA/ CDS/ DIN Rail</li> </ul>
Physical Design	<ul style="list-style-type: none"> <li>• Fanless Design</li> <li>• Jumper-less Design</li> </ul>
<b>Reliability &amp; Protection</b>	
Reverse Power Input Protection	<ul style="list-style-type: none"> <li>• Yes</li> </ul>
Over Voltage Protection	<ul style="list-style-type: none"> <li>• Protection Range: 51-58V</li> <li>• Protection Type: shut down operating voltage, re-power on at the present level to recover</li> </ul>
Over Current Protection	<ul style="list-style-type: none"> <li>• 15A</li> </ul>
CMOS Battery Backup	<ul style="list-style-type: none"> <li>• SuperCap Integrated for CMOS Battery Maintenance-free Operation</li> </ul>
MTBF	<ul style="list-style-type: none"> <li>• 283,091 Hours - Database: Telcordia SR-332 Issue3, Method 1, Case 3</li> </ul>
<b>Environment</b>	
Operating Temperature	<ul style="list-style-type: none"> <li>• -40°C to 70°C</li> <li>* PassMark BurnInTest: 100% CPU, 2D/3D Graphics (without thermal throttling)</li> <li>* With extended temperature peripherals; Ambient with air flow</li> <li>* According to IEC60068-2-1, IEC60068-2-2, IEC60068-2-14</li> </ul>
Storage Temperature	<ul style="list-style-type: none"> <li>• -40°C to 85°C</li> </ul>
Relative Humidity	<ul style="list-style-type: none"> <li>• 95%RH @ 70°C (non-Condensing)</li> </ul>
Shock	<ul style="list-style-type: none"> <li>• Operating, 50 Grms (w/ SSD, according to IEC60068-2-27)</li> </ul>
Vibration	<ul style="list-style-type: none"> <li>• Operating, 5 Grms, 5-500 Hz, 3 Axes (w/ SSD, according to IEC60068-2-64)</li> <li>• Operating, 1 Grms, 10-500 Hz, 3 Axes (w/ SSD, according to IEC60068-2-6)</li> </ul>
EMC	<ul style="list-style-type: none"> <li>• CE, UKCA, FCC, ICES-003 Class A</li> <li>• EN61000-6-4, EN61000-6-2 (24VDC Input Only)</li> </ul>
Safety	<ul style="list-style-type: none"> <li>• UL, cUL, CB, IEC/ EN 62368-1</li> </ul>

*\* Product Specifications and features are for reference only and are subject to change without prior notice. For more information, please refer to the latest product datasheet from Cincoze's website.*



## 1.6 System I/O

### 1.6.1 Front

#### Antenna

Used to install an antenna jack

#### SIM Card Slot

Used to inserts a SIM card

#### Reset Switch

Used to reset the system

#### AT/ATX Switch

Used to select AT or ATX power mode

#### IGN Setting Switch

Used to set up IGN function

#### Clear CMOS

Used to clear CMOS to reset BIOS

#### Front Accessible 2.5" HDD Tray

Used to inserts a 2.5" HDD/SSD

#### Power LED

Indicates the power status of the system

#### HDD LED

Indicates the status of the hard drive

#### Power On/Off

Press to power-on or power-off the system

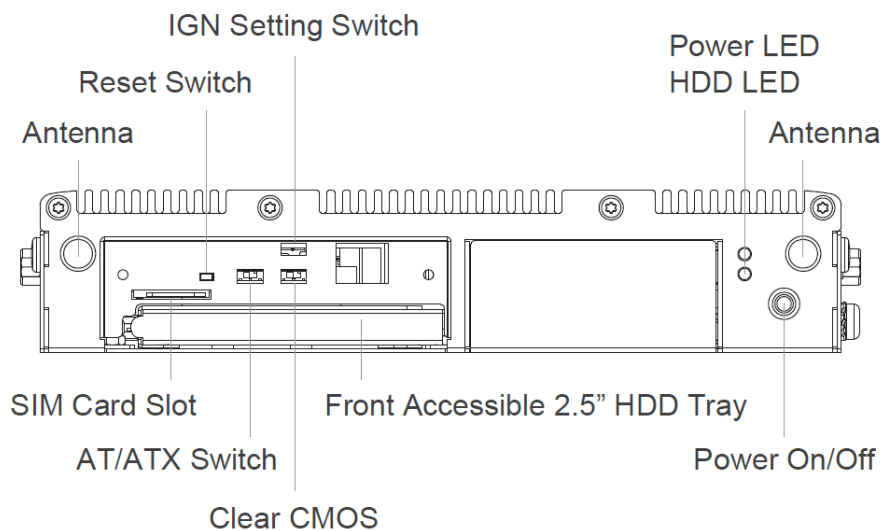

## 1.6.2 Rear

### DC IN

Used to plug a DC power input with terminal block

### USB 3.2 GEN2

Used to connect USB 3.2 GEN2/3.2 GEN1/2.0/1.1 device

### LAN1, LAN2

Used to connect the system to a local area network

### DisplayPort

Used to connect the system with DisplayPort monitor

### VGA

Used to connect an analog VGA monitor

### Remote Power On/Off

Used to plug a remote power on/off terminal block

### Remote Power LED

A terminal block used to connect to remote power on/off LED

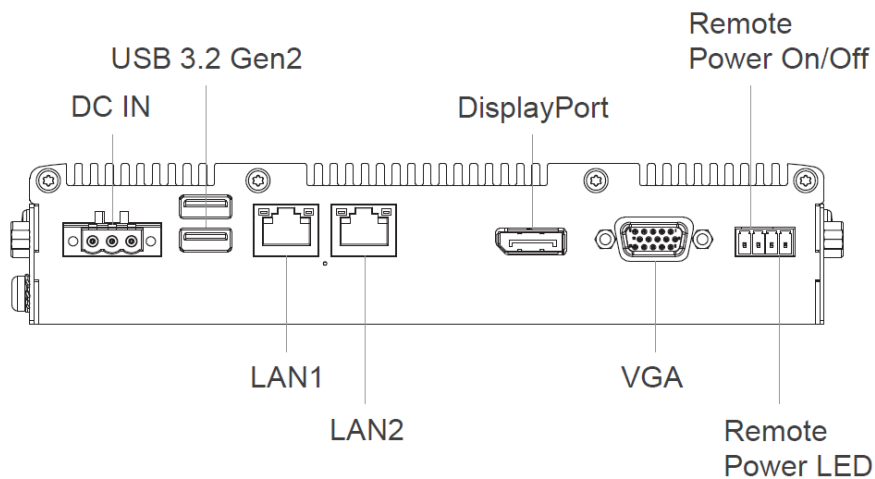

### 1.6.3 Right

**COM3**

COM port supports RS232/422/485 serial device

**DIO**

The Digital I/O terminal block supports 4 digital input and 4 digital output

**USB 2.0**

Used to connect USB 2.0/1.1 device

**Mic-In**

Used to connect a microphone

**Line-Out**

Used to connect a speaker

**Antenna**

Used to install an antenna jack

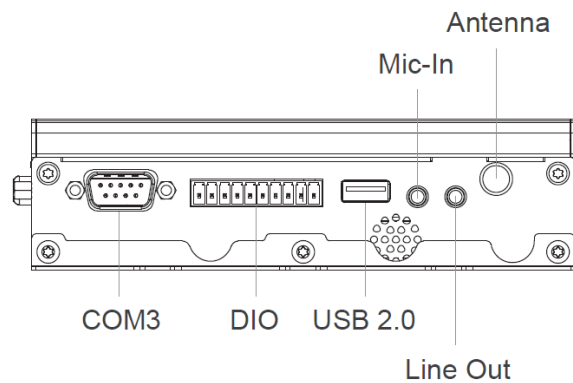

### 1.6.4 Left

**Temperature LED**

Indicates the temperature of the system

**Antenna**

Used to install an antenna jack

**Increase Brightness**

Press to increase brightness of the screen

**Decrease Brightness**

Press to decrease brightness of the screen

**LCD On/Off**

Press to turn-on or turn-off the display

**USB 3.2 GEN2**

Used to connect USB 3.2 GEN2/ 3.2 GEN1/ 2.0/1.1 device

**COM1, COM2**

COM ports support RS232/422/485 serial devices

**GND**

Used to connect to the earth ground to prevent electrical shock

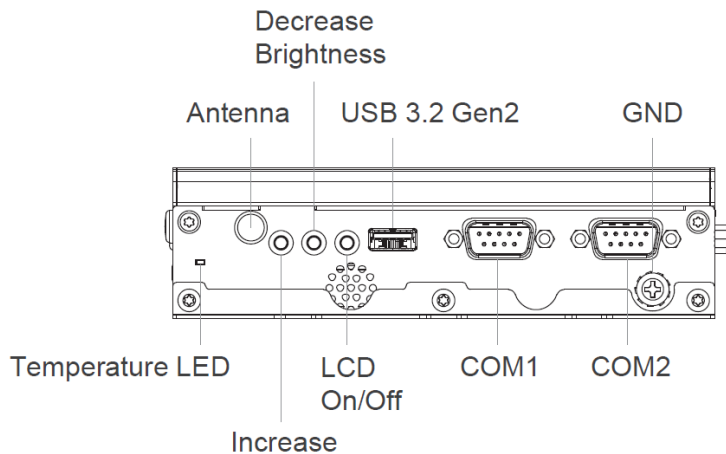

## 1.6.5 Top

### VESA Mounting Hole

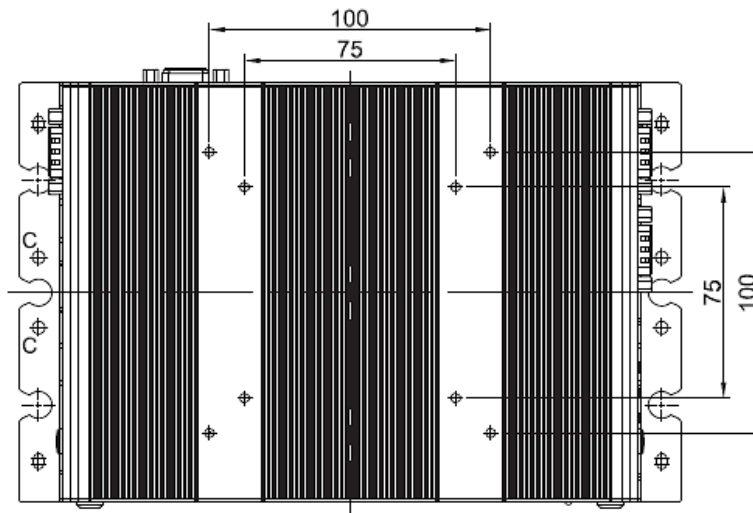

These are mounting holes for VESA mount (75x75mm and 100x100mm)

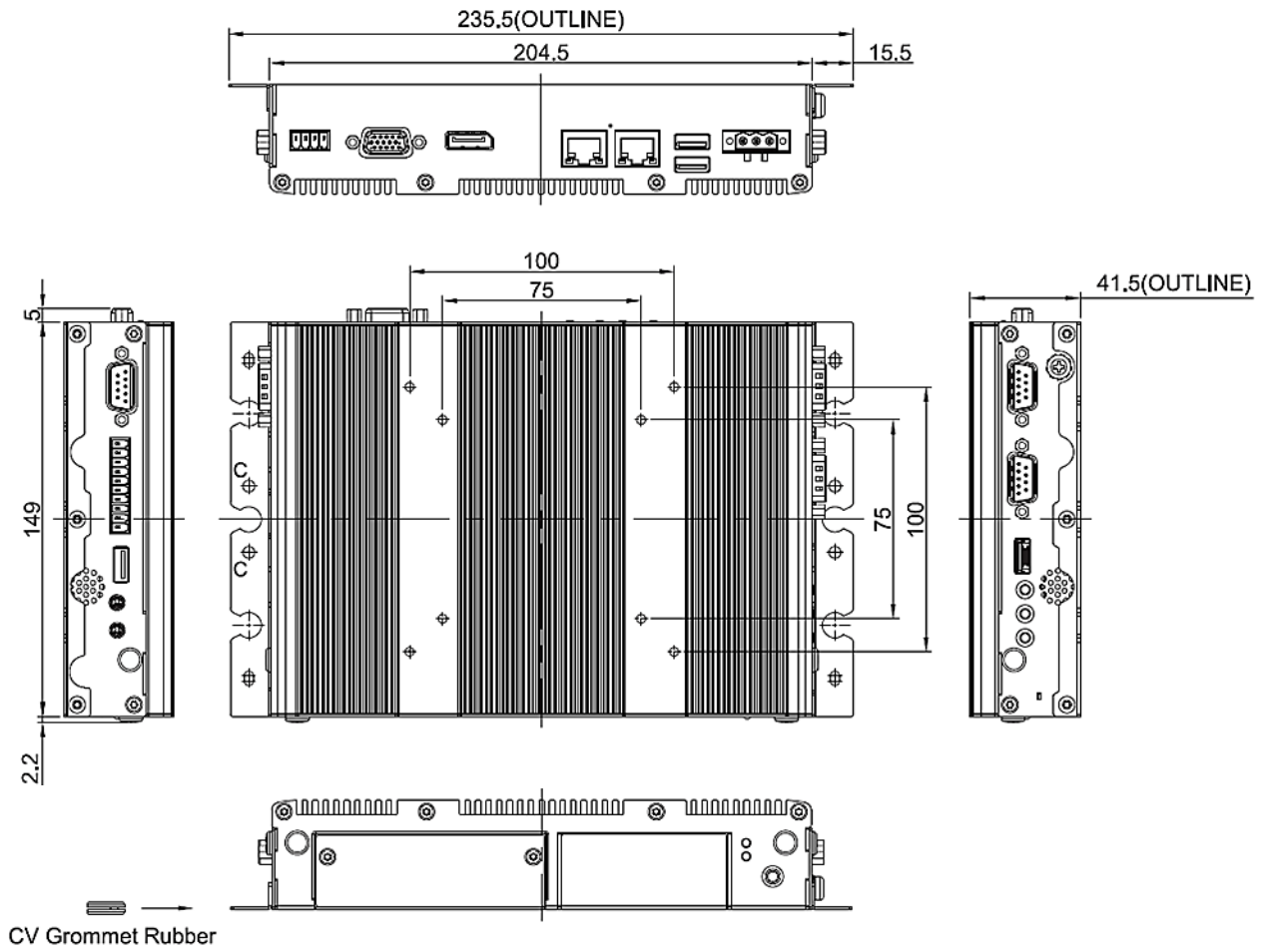

# 1.7 Mechanical Dimension

Unit: mm





# **Chapter 2**

## **Switches & Connectors**

## 2.1 Location of Switches and Connectors

### 2.1.1 Top View

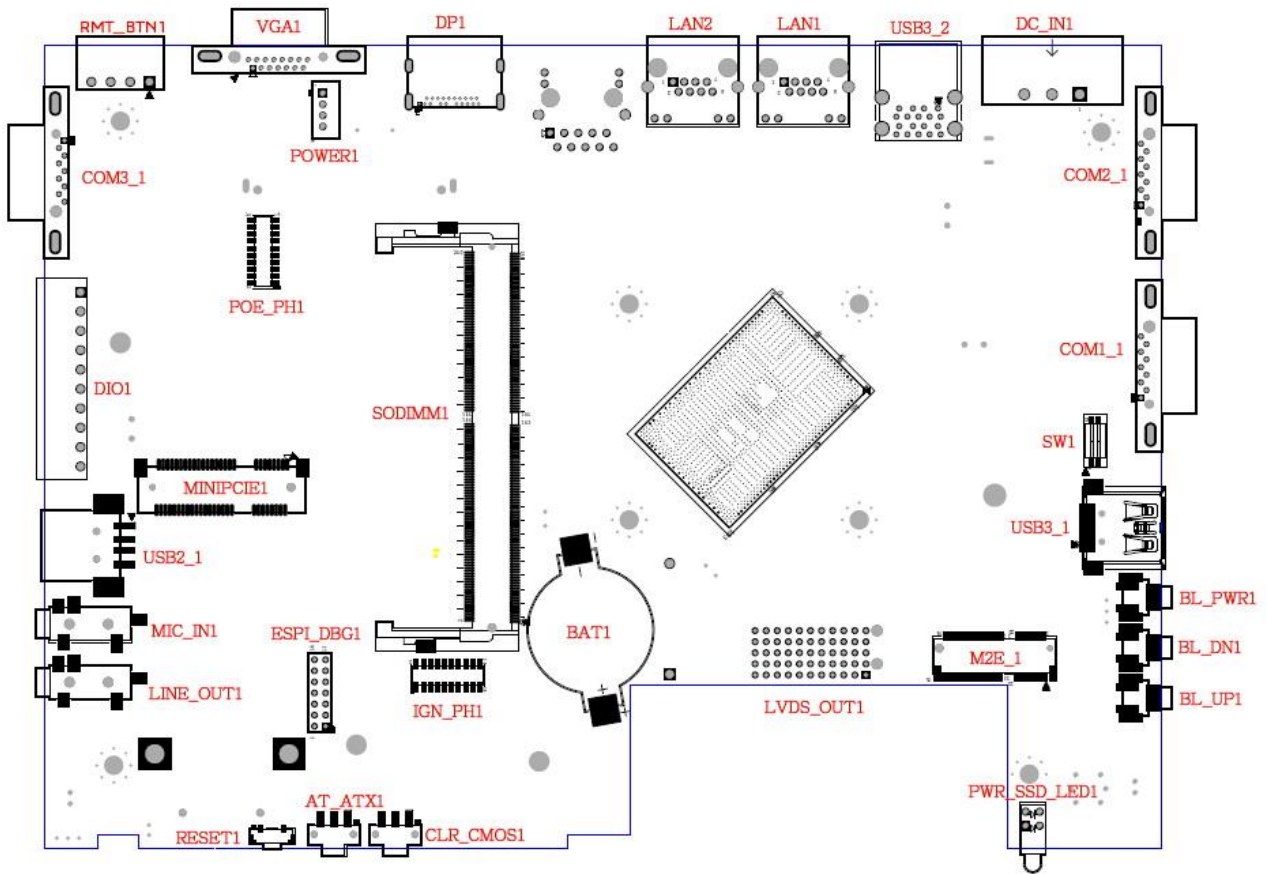

## 2.1.2 Bottom View

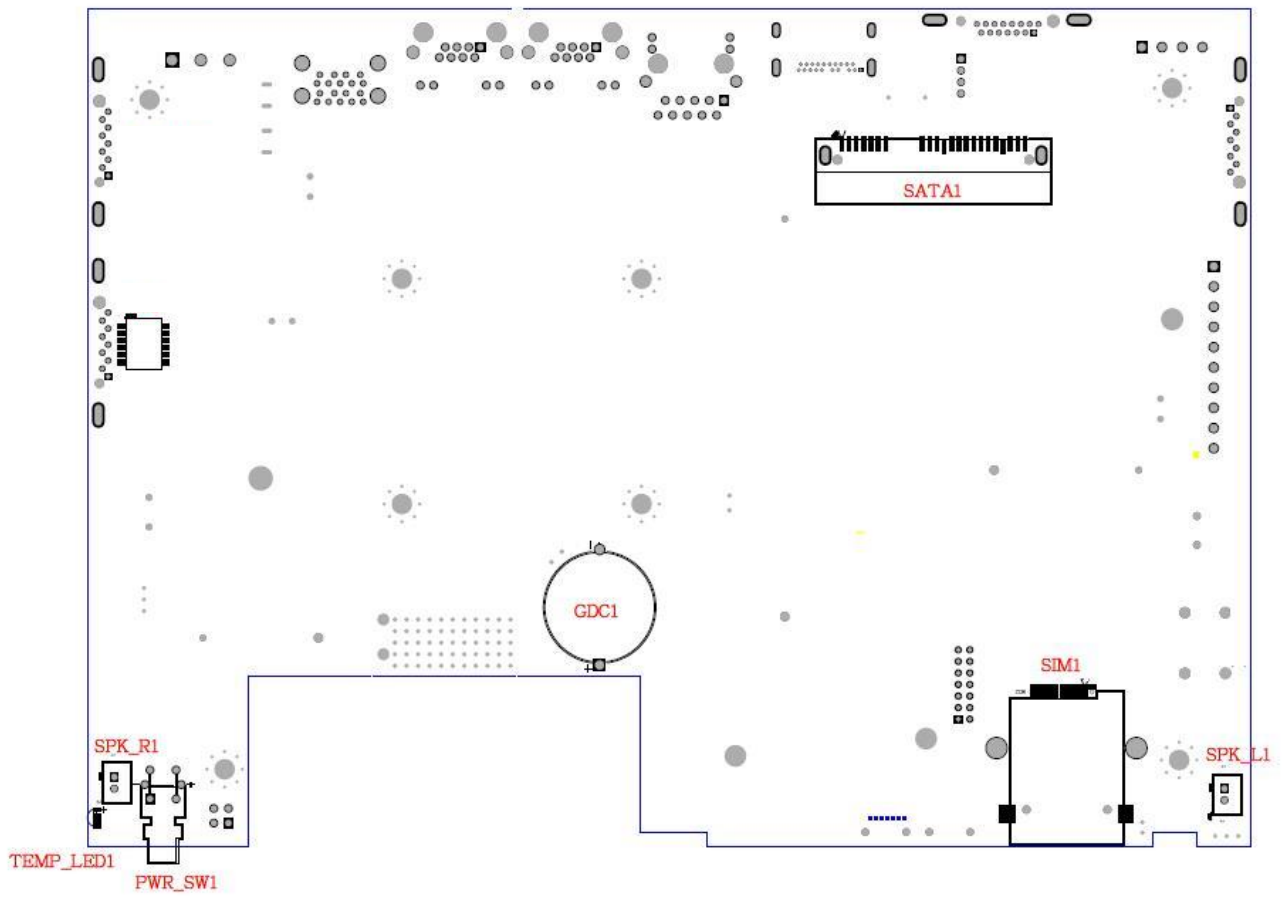



## 2.2 Switches and Connectors Definition

Location	Definition
AT_ATX1	AT / ATX Power Mode Switch
CLR_CMOS1	Clear CMOS Switch
RESET1	Reset Button
BL_UP1	Backlight Brightness Increase Button
BL_DN1	Backlight Brightness Decrease Button
BL_PWR1	Backlight Power On / Off Button
PWR_SW1	Power Switch
SW1	Super CAP SW
PWR_SSD_LED1	Power LED/ HDD LED
TEMP_LED1	Main Board Temperature LED
IGN_PH1	IGN Board to Board Connector
USB3_1 / USB3_2	USB 3.2 GEN2 Connector
USB2_1	USB 2.0 Connector
COM1_1 / COM2_1 / COM3_1	DB9 Connectors, RS232 / RS422 / RS485 Connector
DC_IN1	DC 9-48V Power Connector
LAN1/ LAN2	LAN Connector
VGA1	VGA Connector
DP1	DisplayPort Connector
DIO1	4DI / 4DO Connector
MIC_IN1	Mic-in Jack
LINE_OUT1	Line-Out Jack
MINIPCIE1	Mini PCI-Express Socket (PCIE/ USB3.0/ mSATA Module)
M2E_1	M.2 Key E Connector (Support PCIE type only)
RMT_BNT1	Remote Power Button/ Remote LED Connector
Power1	+5V / +12V Power Output
SATA1	SATA Connector
POE_PH1	POE Board to Board Connector
SODIMM1	DDR4 SODIMM Slot
SIM1	SIM Card socket
SPK_R1	Speaker Out Connector for right side

SPK_L1	Speaker Out Connector for left side
GDC1	Super CAP for CMOS Backup
BAT1	RTC Battery Holder

## 2.3 Definition of Switches

### AT\_ATX1: AT / ATX Power Mode Switch

Switch	Definition
1-2 (Right)	ATX Power Mode (Default)
2-3 (Left)	AT Power Mode

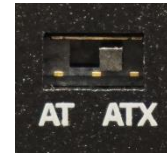

### PWR\_SW1: System Power Button

Switch	Definition
Push	Power System



### CLR\_CMOS1: Clear CMOS Switch

Switch	Definition
1-2 (Right)	Clear CMOS
2-3 (Left)	Normal Status (Default)



### BL\_PWR1: Backlight Power on / off

Switch	Definition
Push	Backlight Power on / off switching



### BL\_UP1: Backlight Brightness Increase

Switch	Definition
Push	Backlight Brightness Increase



### BL\_DN1: Backlight Brightness Decrease

Switch	Definition
Push	Backlight Brightness Decrease



### RESET1: Reset Button

Switch	Definition
Push	Reset System

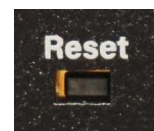

### SW1: Super CAP SW

Location	Function	DIP1	DIP2
SW1	Super Cap	Enabled	ON (Default)
		Disabled	OFF



ON  
OFF

### PWR\_SSD\_LED1: Power / HDD Access LED Status

LED	LED Color	Status
POWER	Green	POWER ON
HDD	Blinking Orange	HDD Read/Write



### LAN1 / LAN2: LAN LED Status Definition

Act LED Status	Definition
Yellow & Blinking	Data Activity
Off	No Activity

Link LED Status	Definition
Green	1Gbps Network Link
Orange	100Mbps Network Link
Off	10Mbps Network Link

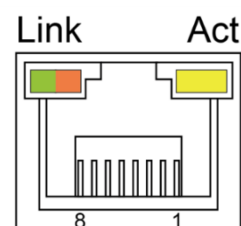

### TEMP\_LED1: Main Board Temperature LED Status

LED Status	Status
OFF	Main Board Temp $\leq 60^{\circ}\text{C}$
Blue	$60^{\circ}\text{C} < \text{Main Board Temp} \leq 87^{\circ}\text{C}$
Red	$87^{\circ}\text{C} \leq \text{Main Board Temp}$



## 2.4 Definition of Connectors

### MINIPCIE1 : Mini PCI-Express Socket (mPCIE/ USB3/ SIM Module)

Pin No.	PIN Name	Pin No.	Pin name
1	WAKE#	2	+3.3V
3	N/A	4	GND
5	N/A	6	1.5V
7	CLKREQ#	8	SIM_VCC
9	GND	10	SIM_DATA
11	REFCLK-	12	SIM_CLK
13	REFCLK+	14	SIM_Reset
15	GND	16	UIM_VPP (SIM_VPP)
Mechanical Key			
17	N/A	18	GND
19	N/A	20	W_DISABLE#
21	GND	22	PERST#
23	PERN (USB3RN)/ SATA_RXP	24	+3.3V
25	PERP (USB3RP)/ SATA_RXN	26	GND
27	GND	28	+1.5V
29	GND	30	SMB_CLK
31	PETN (USB3TN)/ SATA_TXN	32	SMB_DATA
33	PETP (USB3TP)/ SATA_TXP	34	GND
35	GND	36	USB_D-
37	GND	38	USB_D+
39	+3VSB_MPCIE_FB	40	GND
41	+3VSB_MPCIE_FB	42	N/A
43	GND	44	N/A
45	N/A	46	N/A
47	N/A	48	+1.5V
49	N/A	50	GND
51	W_DISABLE2#	52	+3.3V

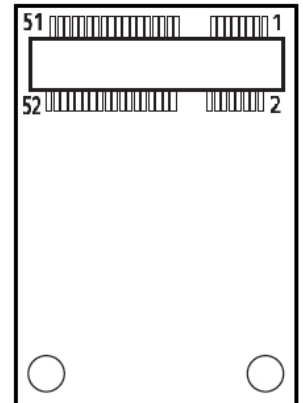

## M2E\_1 : M.2 Key E Connector (Support PCIE type only)

Pin No.	PIN Name	Pin NO.	Pin name
1	GND	2	+3.3V
3	USB_D+	4	+3.3V
5	USB_D-	6	N/A
7	GND	8	PCM_CLK
9	N/A	10	PCM_SYNC/LPC_RSTN
11	N/A	12	PCM_IN
13	GND	14	PCM_OUT
15	N/A	16	N/A
17	N/A	18	GND
19	GND	20	UART_WAKE#
21	N/A	22	UART_RX/BRI_RSP
23	N/A	24	Key
25	Key	26	Key
27	Key	28	Key
29	Key	30	Key
31	Key	32	UARTX/RGI_DT
33	GND	34	UART_CTS/RGI_RSP
35	PETP0	36	UART_RTS/BRI_DT
37	PETN0	38	N/A
39	GND	40	N/A
41	PERP0	42	N/A
43	PERN0	44	N/A
45	GND	46	N/A
47	REFCLKP0	48	N/A
49	REFCLKN0	50	SUSCLK
51	GND	52	PERST0#
53	CLKREQ0#	54	W_DISABLE2# (PULL-UP)
55	PEWAKE0#	56	W_DISABLE1# (PULL-UP)
57	GND	58	I2C_DATA
59	WTD1N/PETP1	60	I2C_CLK
61	WTD1P/PETN1	62	N/A
63	GND	64	N/A
65	WT_DON/PERP1	66	PERST1#
67	WT_DOP/PERN1	68	CLKREQ1#

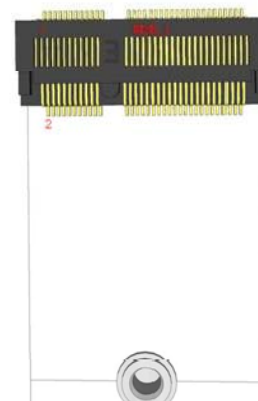

69	GND	70	PEWAKE1#
71	WTCLKN/REFCLKP1	72	+3.3V
73	WTCLKP/REFCLKN1	74	+3.3V
75	GND		

### DC\_IN1: DC Power Input Connector (9-48V)

Connector Type: Terminal Block 1x3 3-pin, 5.0mm pitch

Pin	Definition
1	9-48V IN
2	Ignition (IGN)
3	GND

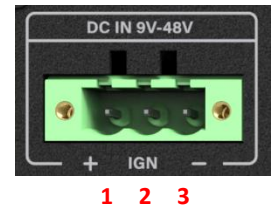

**CAUTION**  
(ATTENTION)

Please disconnect the power source before mounting the DC power cables or connecting the DC power connector to system.  
(Veuillez débrancher la source d'alimentation avant de monter les câbles d'alimentation CC ou de connecter le connecteur d'alimentation CC au système.)

### RMT\_BNT1: Remote Power Button/ Remote LED Connector

Remote Power LED connector can connect an external LED indicator up to 10mA. Connector Type: Terminal Block 1X4 4-pin, 3.5mm pitch

Pin	Definition
1	Remote Power Button
2	GND
3	Remote Power LED
4	GND

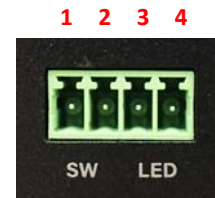

**WARNING**  
(AVERTIR)

Do not apply power to this connector! This port is used to connect a SWITCH!  
(Ne mettez pas sous tension ce connecteur! Ce port est utilisé pour connecter un SWITCH!)

**COM1\_1 / COM2\_1 / COM3\_1: RS232 / RS422 / RS485 Connector**

Connector Type: 9-pin D-Sub

Pin	RS232 Definition	RS422 / 485 Full Duplex Definition	RS485 Half Duplex Definition
1	DCD	TX-	DATA -
2	RXD	TX+	DATA +
3	TXD	RX+	
4	DTR	RX-	
5	GND		
6	DSR		
7	RTS		
8	CTS		
9	RI		





**POWER1: +5V / +12V Power Output**

Connector Type: 1x4 4-pin Wafer, 2.0mm pitch

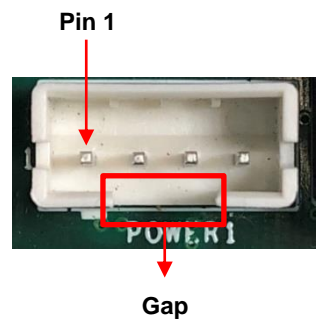
Pin	Definition
1	+5V
2	GND
3	GND
4	+12V





# **Chapter 3**

## **System Setup**



## 3.1 Removing Top Cover



**WARNING**  
**(AVERTIR)**

In order to prevent electric shock or system damage, must turn off power and disconnect the unit from power source before removing the chassis cover.

(Afin d'éviter tout risque d'électrocution ou d'endommagement du système, vous devez couper l'alimentation et débrancher l'appareil de la source d'alimentation avant de retirer le couvercle du châssis.)

1. Loosen the 8 screws of front and rear panel, then place them aside.



2. Remove the cover from the chassis.



3. Place the top cover gently.

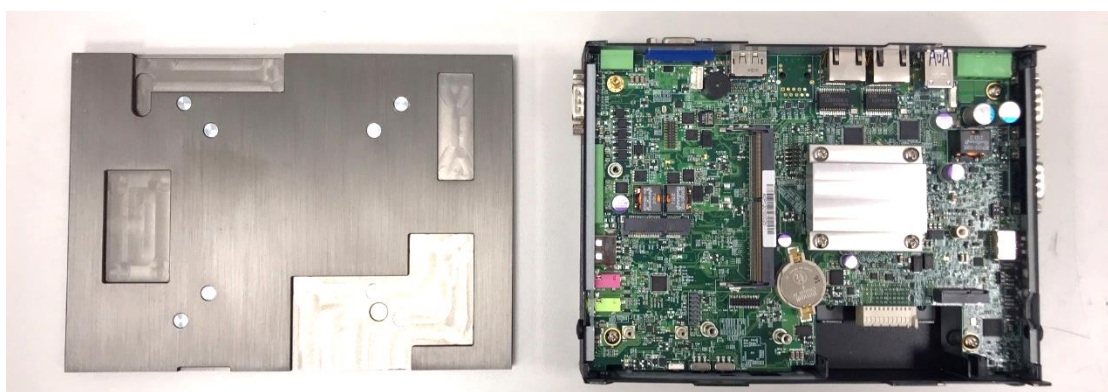

## 3.2 Installing SO-DIMM Memory

1. Locate the SO-DIMM sockets.

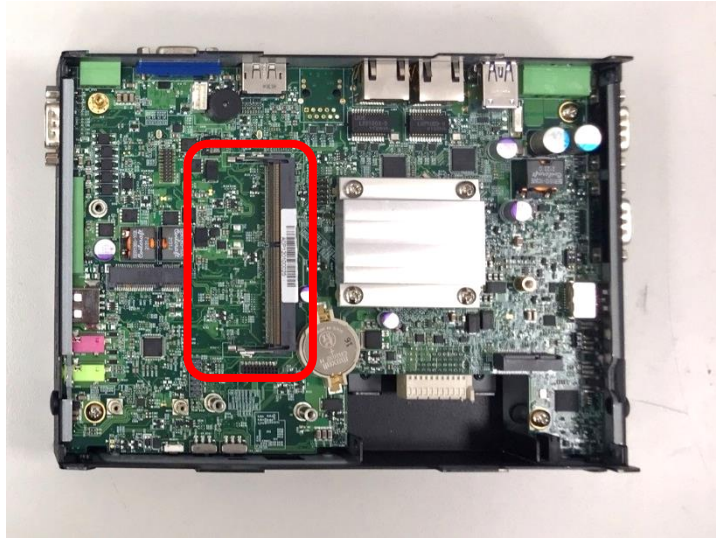

2. Tilt the SO-DIMM module at a 45-degree angle and insert it to SO-DIMM socket until the gold-pated connector of module contacted firmly with the socket.



3. Press the modules down until it's fixed firmly by the two locking latches on each side.

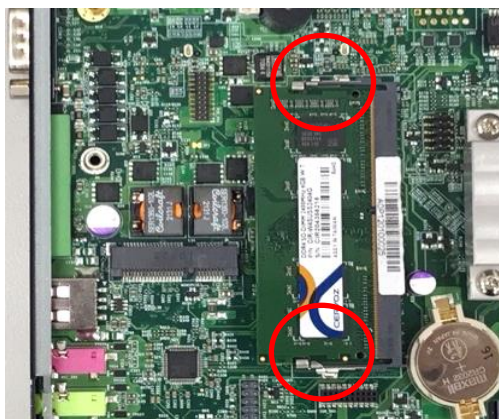

### 3.3 Installing Mini-PCIe Card

(Applicable for full or half size card)

1. Locate the Mini PCIe slot.

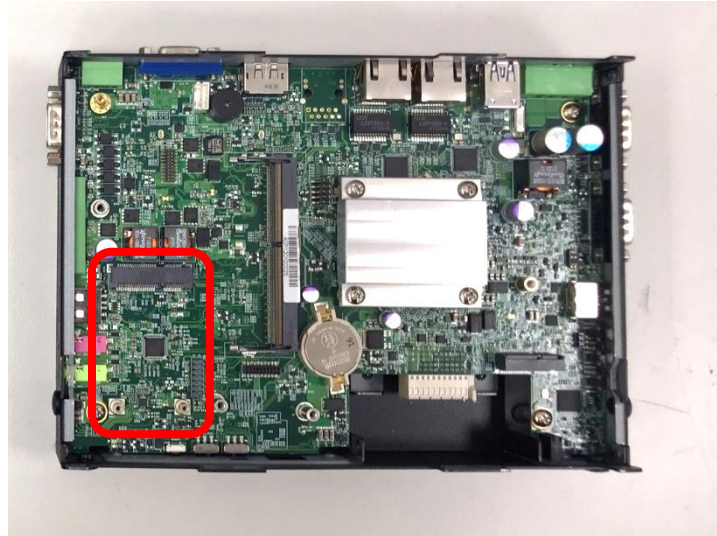

2. Insert the Mini-PCIe card at a 45-degree angle and insert it to the slot until the gold-pated connector of module contacted firmly with the slot.



3. Press down the module and fasten two screws to secure the module.

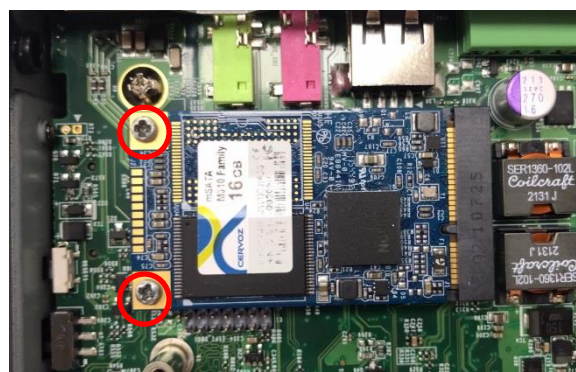

4. If you have a Half-size Mini-PCIe card, make sure use extender to make it Full-size as shown below.



### 3.4 Installing M.2 E Key Card

1. Locate the M.2 E Key slot on the system board.

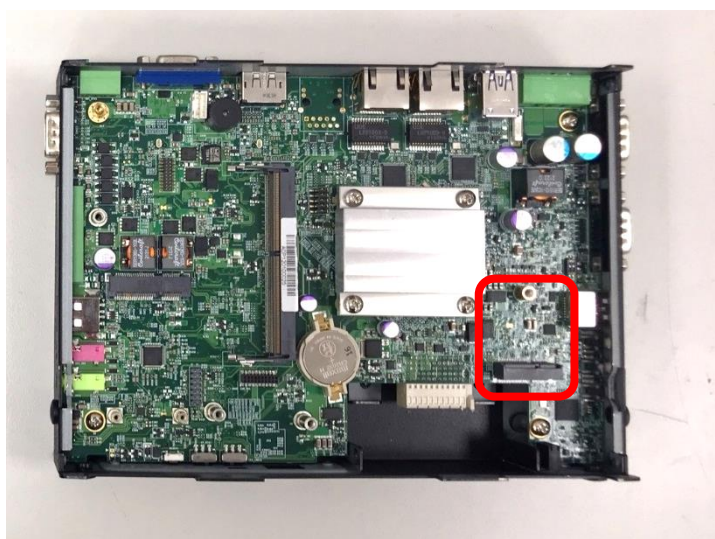

2. Tilt the M.2 E Key card at a 45-degree angle and insert it to the socket until the golden finger connector of the card seated firmly.

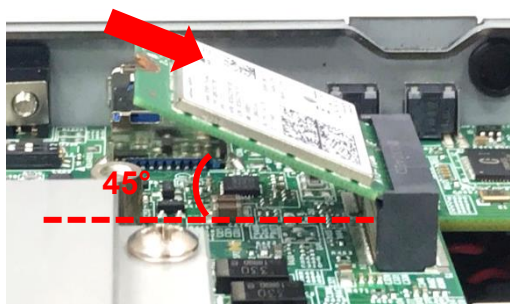

3. Press the card down and secure it with 1 screw.



### 3.5 Installing Antenna(s)

Please install a mPCIe Wireless Lan card before putting on the washer and fasten the nut to the antenna jack.

1. Remove the antenna hole covers at front or side panel.



2. Have antenna jack penetrate through the hole.



3. Put on washer and fasten the nut with antenna jack.



4. Assemble the antenna and antenna jack together.



5. Attach the RF connector at another end of cable onto the module.

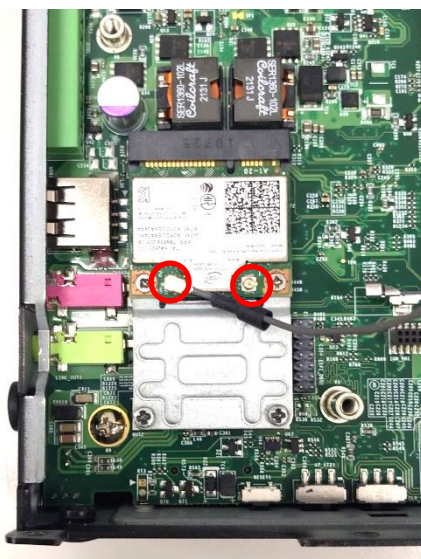

### 3.6 Installing CPU Thermal Pad

1. Place the thermal pad on the CPU heatsink.

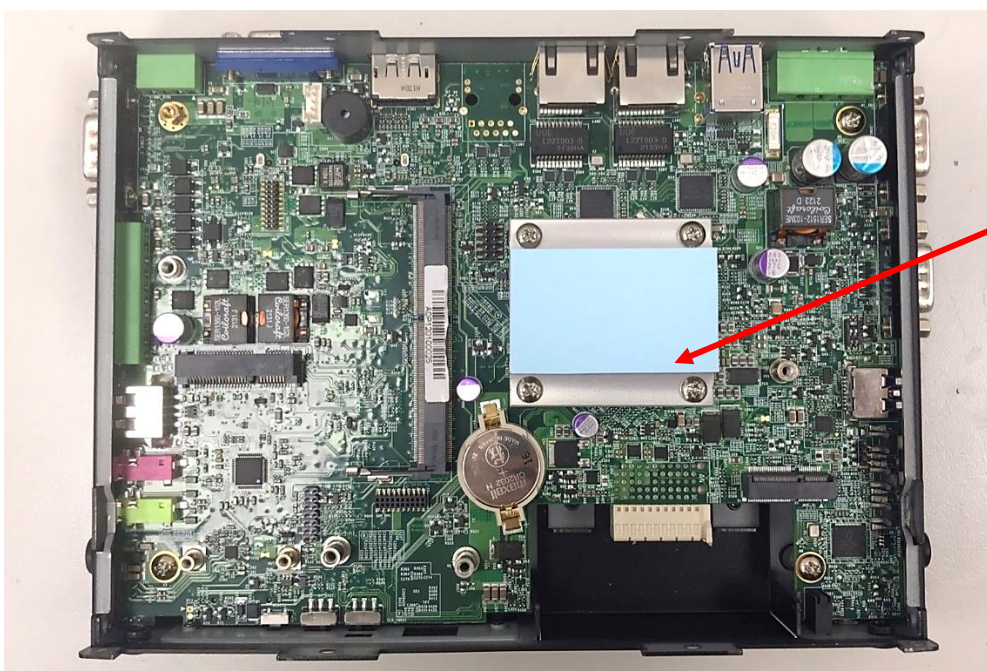

thermal pad



CAUTION  
(ATTENTION)

Before assembling the system's chassis cover, please make sure the protective film on the Thermal Pad has been removed!

(Avant d'assembler le couvercle du châssis du système, assurez-vous que le film protecteur sur le coussin thermique a été retiré !d'alimentation CC au système.)

## 3.7 Installing Top Cover

1. Put on the cover.



2. Fasten the 8 screws to fix the cover.





## 3.8 Installing SATA Hard Drive

1. Loosen 2 screws on front panel to remove cover plate.



2. Turn over the unit to have the bottom side face up and loosen 1 screw.

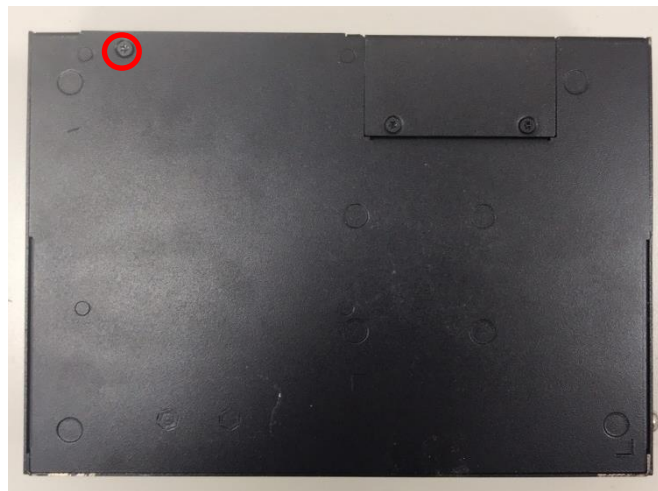

3. Pull out the HDD bracket.



4. Make the bottom side of the HDD face up, place the HDD bracket on it. Ensure the direction of bracket is correct and use 4 provided screws to assemble HDD and HDD bracket together.

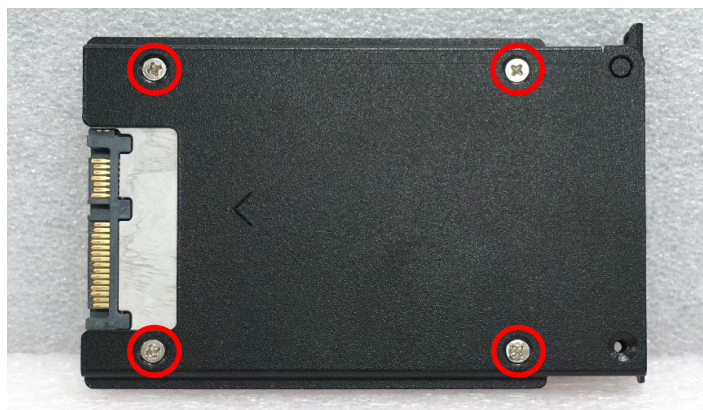

5. Align the HDD bracket with the entrance of HDD bay. And insert the HDD bracket until the connector of HDD contact the SATA connector firmly.



6. Turn over the unit to have the bottom side face up and fasten the screw.

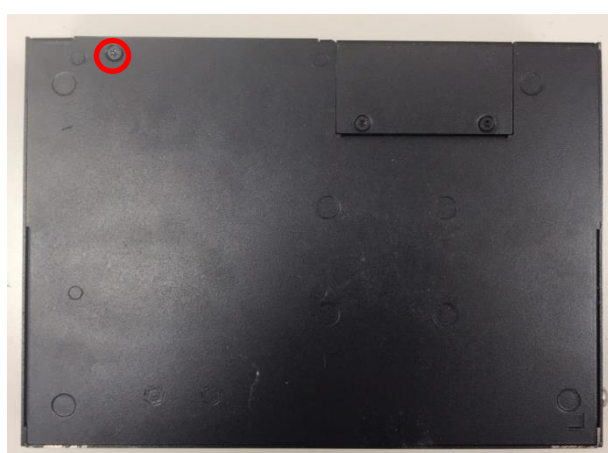

## 3.9 Installing SIM Card

1. Loosen 2 screws on front panel to remove cover plate.



2. SIM card slot is at the front panel of the system.



3. Insert the SIM card.



### 3.10 Installing Wall Mount

1. Prepare wall mounting kit (two wall brackets and one screw pack with size of M3-0.5x5). De-attach six rubber holes from the mounting brackets as indicated.

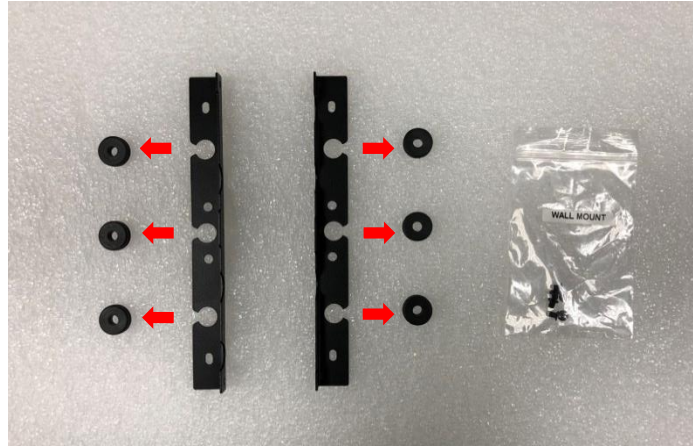

2. Remove the screws on the side panels.



3. Assemble two wall mount brackets by fastening three screws on each side.

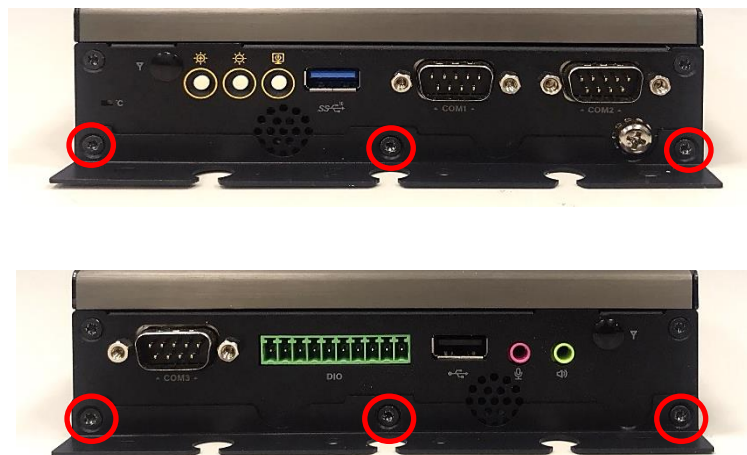

4. Attach the system to the wall by fastening four screws through the mounting holes at each side as illustrated.

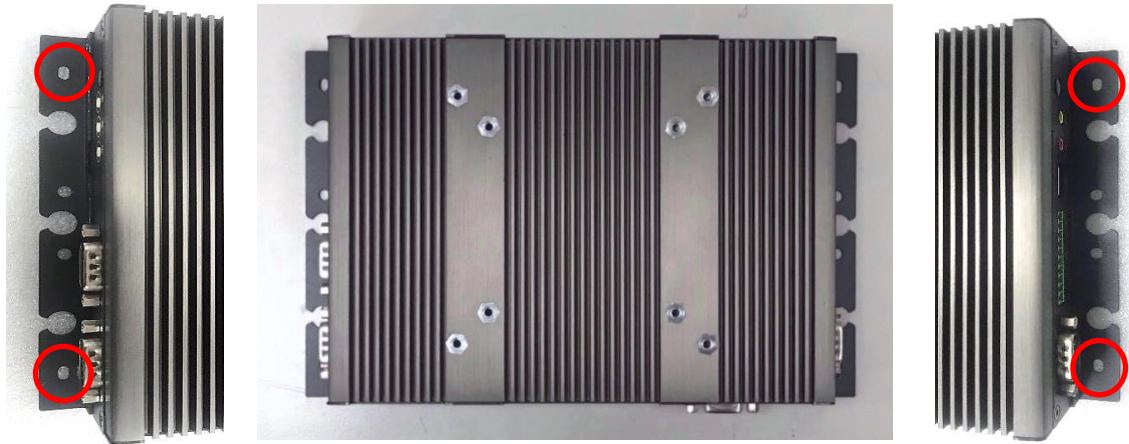

## 3.11 Installing DIN-Rail Mount

P1201 series offers DIN-Rail Mounting Kit (DIN01) that customer can install system on the DIN Rail. Before starting this chapter, please follow chapter 3.10 to assemble the wall mount brackets first.



1. Fasten each DIN rail mounting clip onto the wall mounting bracket with 2 screws (screw size: T3x10.5).



2. Clip the system into DIN rail as illustrated below.



### 3.12 Installing VESA Mount

The following picture indicates VESA mounting holes on the P1201 series, which is compliant with VESA mounting standard.

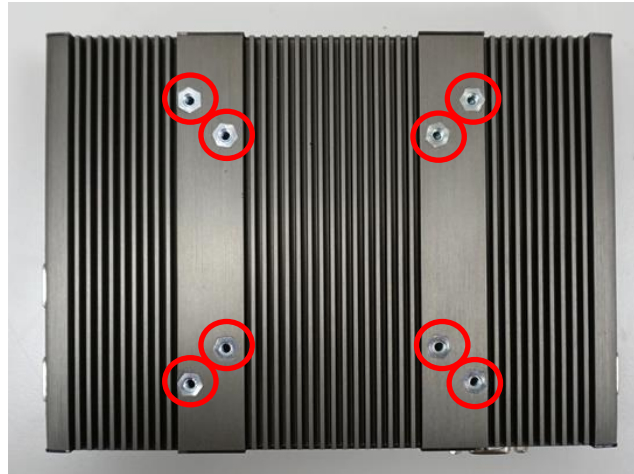

1. Please fasten eight screws as indicated to fix it on the stand.

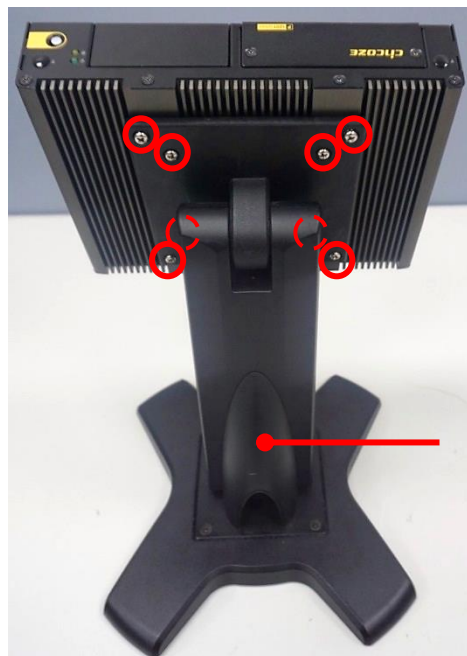

VESA stand

### 3.13 Connecting with Display Module

1. Please follow the instruction of chapter 3.10 to install wall mount bracket first, and then locate the module connector slot.



2. Turn over the unit to have the bottom side face up, loosen the 2 screws of the module connector bracket.

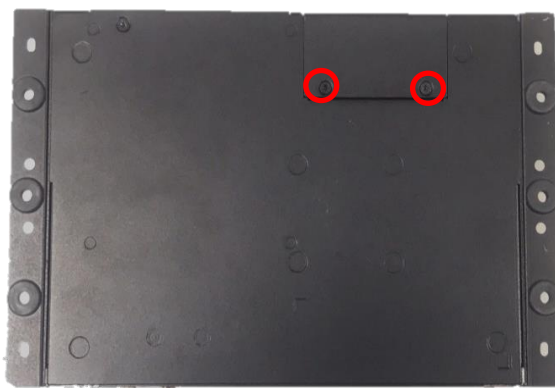

The photos below show the male connector (on the display module)



, and the female connector (on the PC module),





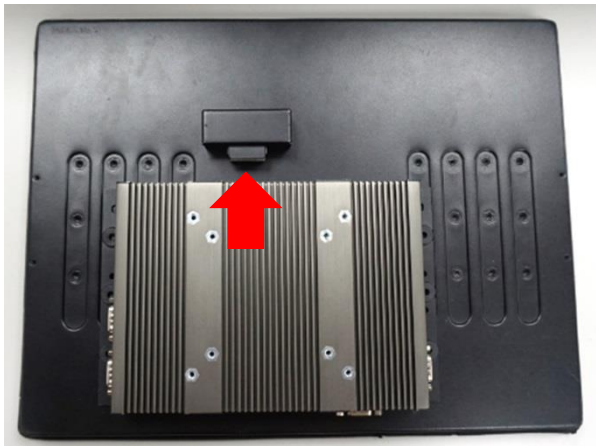

3. Connect the modules.

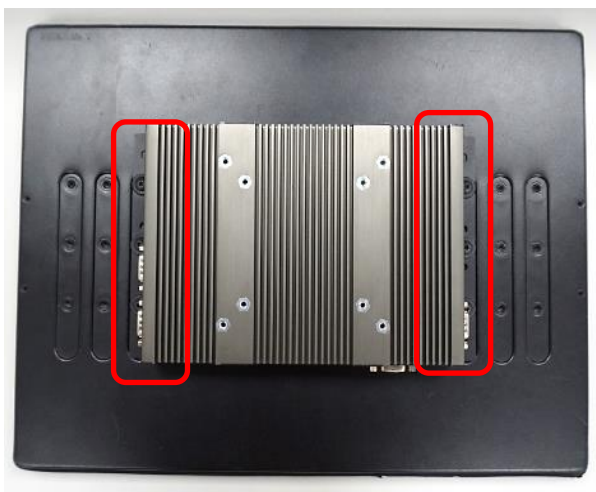

4. Fasten the 6 screws to fix the PC module on the display module.





# **Chapter 4**

## **BIOS Setup**

## 4.1 BIOS Introduction

The BIOS (Basic Input/ Output System) is a program located on a Flash Memory on the motherboard. When you start the computer, the BIOS program will gain control. The BIOS first operates an auto-diagnostic test called POST (power on self-test) for all the necessary hardware, it detects the entire hardware device and configures the parameters of the hardware synchronization.

### BIOS Setup

Power on the computer and by pressing <Del> immediately allows you to enter Setup. If the message disappears before your respond and you still wish to enter Setup, restart the system to try again by turning it OFF then ON or pressing <Ctrl>, <Alt> and <Delete> keys.

Control Keys	
<←> <→>	Move to select screen
<↑> <↓>	Move to select item
<Esc>	Quit the BIOS Setup
<Enter>	Select item
<Page Up/+>	Increases the numeric value or makes changes
<Page Down/->	Decreases the numeric value or makes changes
<Tab>	Select setup fields
<F1>	General help
<F2>	Previous value
<F3>	Load Optimized defaults
<F10>	Save configuration and Exit

### Main Menu

The main menu lists the setup functions you can make changes to. You can use the arrow keys ( ↑↓ ) to select the item. The on-line description of the highlighted setup function is displayed at the bottom of the screen.

### Sub-Menu

If you find a right pointer symbol appears to the left of certain fields that means a sub-menu can be launched from this field. A sub-menu contains additional options for a field parameter. You can use arrow keys ( ↑↓ ) to highlight the field and press <Enter> to call up the sub-menu. Then you can use the control keys to enter values and move from field to field within a sub-menu. If you want to return to the main menu, just press the <Esc >.

## 4.2 Main Setup

Press <Del> to enter BIOS CMOS Setup Utility, the Main Menu (as shown below) will appear on the screen. Use arrow keys to move among the items and press <Enter> to accept or enter a sub-menu.

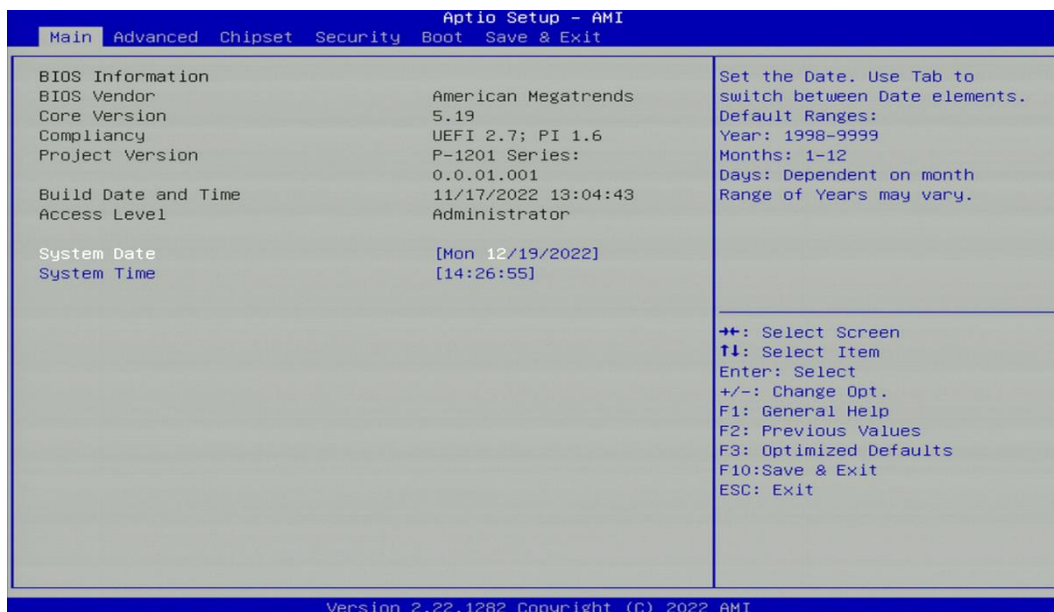

### ■ System Date

Set the date. Please use <Tab> to switch between date elements.

### ■ System Time

Set the time. Please use <Tab> to switch between time elements.

## 4.3 Advanced Setup

This section allows you to configure and improve your system and allows you to set up some system features according to your preference.

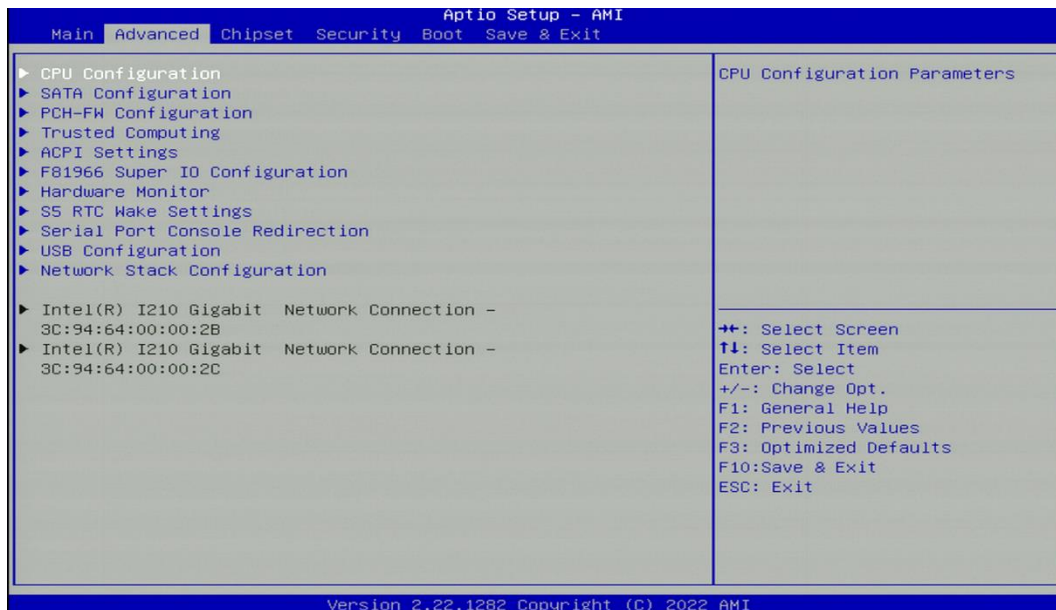

### 4.3.1 CPU Configuration

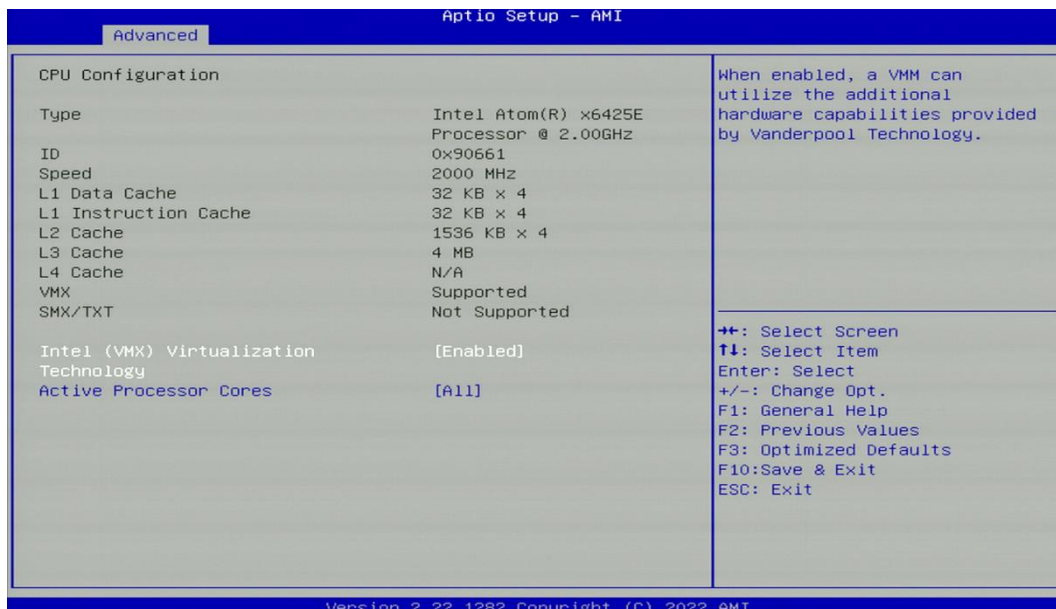

#### ■ Intel Virtualization Technology [Enabled]

Enables or disables Intel Virtualization Technology. Virtualization enhanced by Intel Virtualization Technology will allow a platform to run multiple operating systems and applications in independent partitions. With virtualization, one computer system can function as multiple virtual systems.

#### ■ Active Processor Cores [All]

Number of cores to enable in each processor package.

### 4.3.2 SATA Configuration

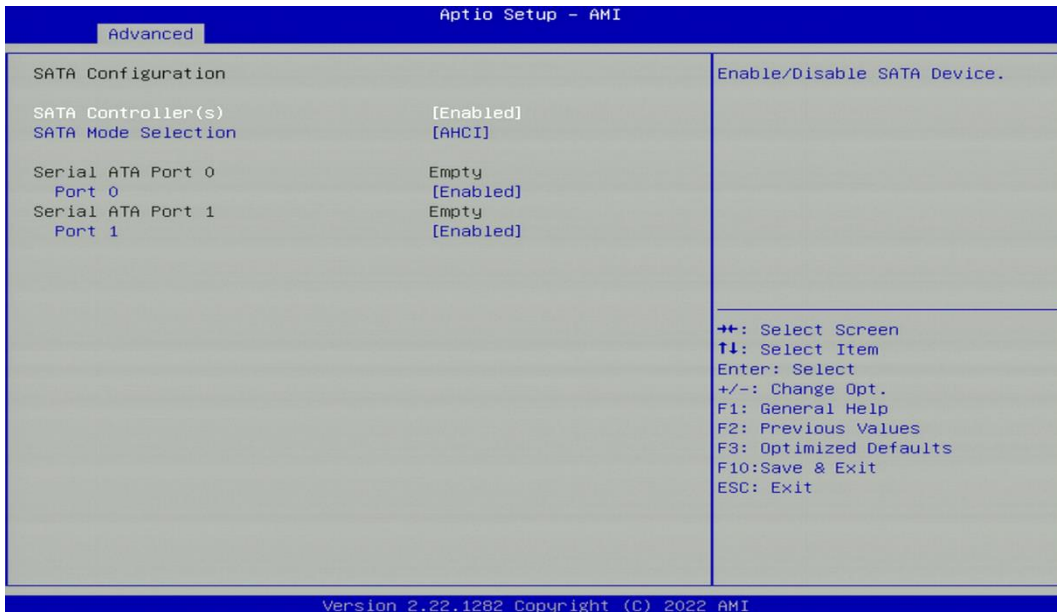

#### ■ SATA Controller(s) [Enabled]

Enables or disables SATA device.

#### ■ SATA Mode Selection [AHCI]

Allows you to select which mode SATA controller will operate.

Configuration options: [AHCI]

#### Serial ATA Port 0

##### Port 0 [Enabled]

Enables or disables SATA Port 0.

#### Serial ATA Port 1

##### Port 1 [Enabled]

Enables or disables SATA Port 1.

### 4.3.3 PCH-FW Configuration

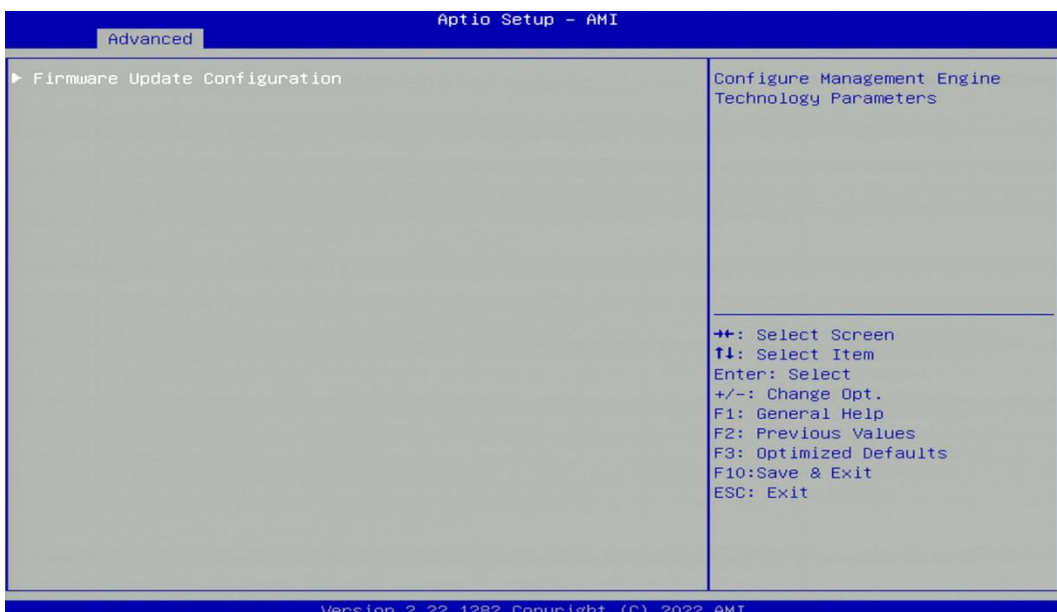

## ■ Firmware Update Configuration

Configure Management Engine Parameters

### ❑ Me FW Image Re-Flash [Disabled]

Enables or disables ME firmware Image Re-Flash function.

## 4.3.4 Trusted Computing Settings

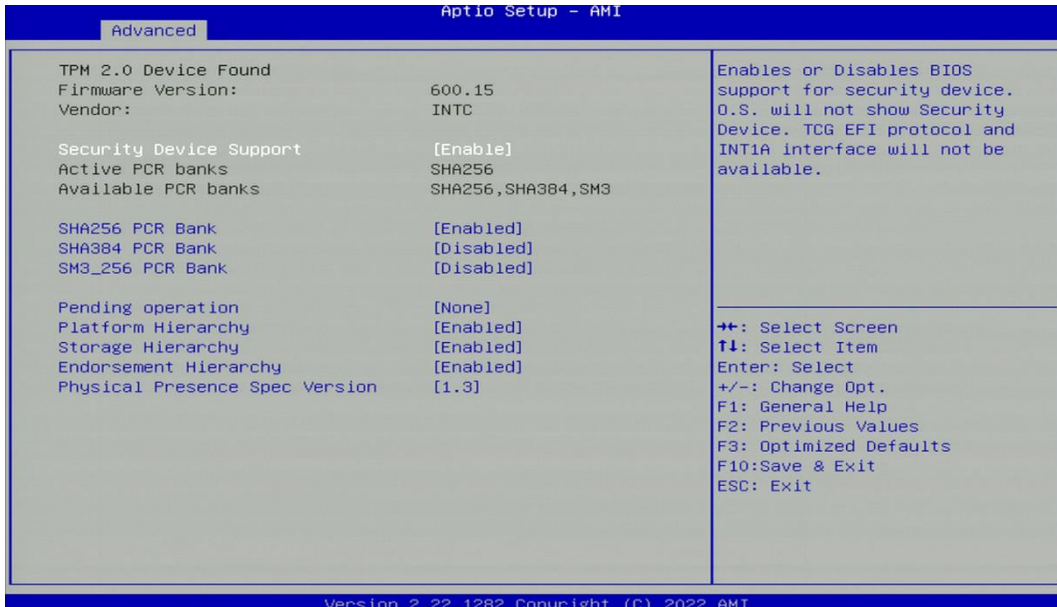

### ■ Security Device Support [Enabled]

Enables or disables Security Device Support function.

### ■ SHA256 PCR Bank [Enabled]

Enables or disables SHA256 PCR Bank function.

### ■ SHA384 PCR Bank [Disabled]

Enables or disables SHA384 PCR Bank function.

### ■ SM3\_256 PCR Bank [Disabled]

Enables or disables SM3\_256 PCR Bank function.

### ■ Pending Operation [None]

Allows you to select which mode Pending Operation will operate.

Configuration options: [None], [TPM Clear]

### ■ Platform Hierarchy [Enabled]

Enables or disables Platform Hierarchy function.

### ■ Storage Hierarchy [Enabled]

Enables or disables Storage Hierarchy function.

### ■ Endorsement Hierarchy [Enabled]

Enables or disables Endorsement Hierarchy function.

### ■ Physical Presence Spec Version [1.3]

Allows you to select which mode Physical Presence Spec Version will operate.

Configuration options: [1.2], [1.3]

### 4.3.5 ACPI Settings



#### ■ Enable Hibernation [Enabled]

Enables or disables system ability to hibernate state (OS/S4 state). This option may not be effective with some OS.

#### ■ ACPI Sleep State [S3 (Suspend to RAM)]

Allows users to select the highest Advanced Configuration Power Interface® (ACPI) sleep state that system will enter when suspend button is pressed.

[Suspend Disabled]: Disables entering suspend state.

[S3 (suspend to RAM)]: Enables suspend to RAM state.

### 4.3.6 F81966 Super IO Configuration

Set Parameters of Serial Ports. User can Enable/Disable the serial port and Select an optimal setting for the Super IO Device.

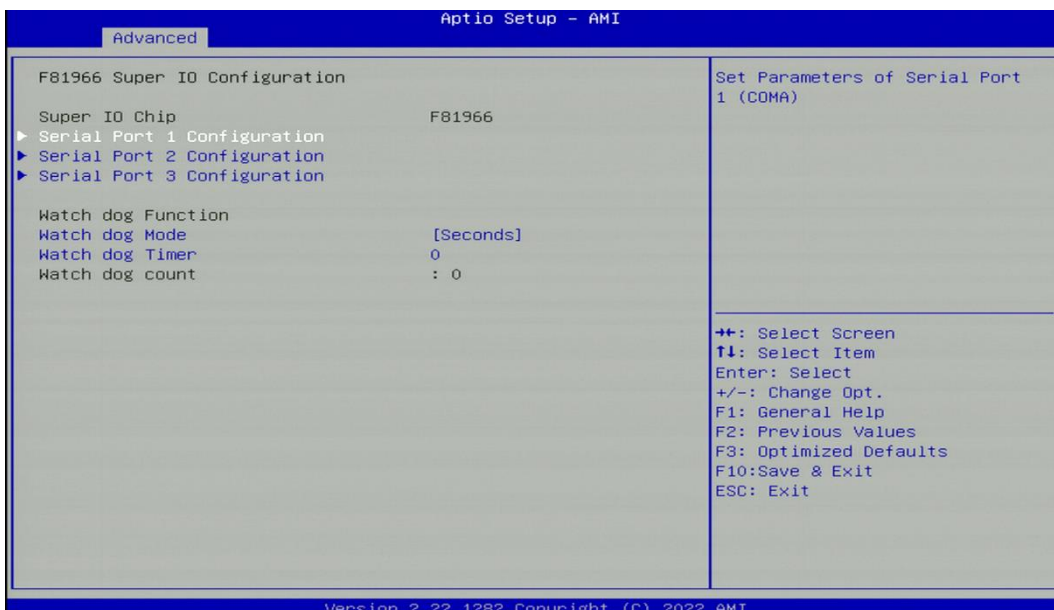



## ■ Serial Port 1~3 Configuration.

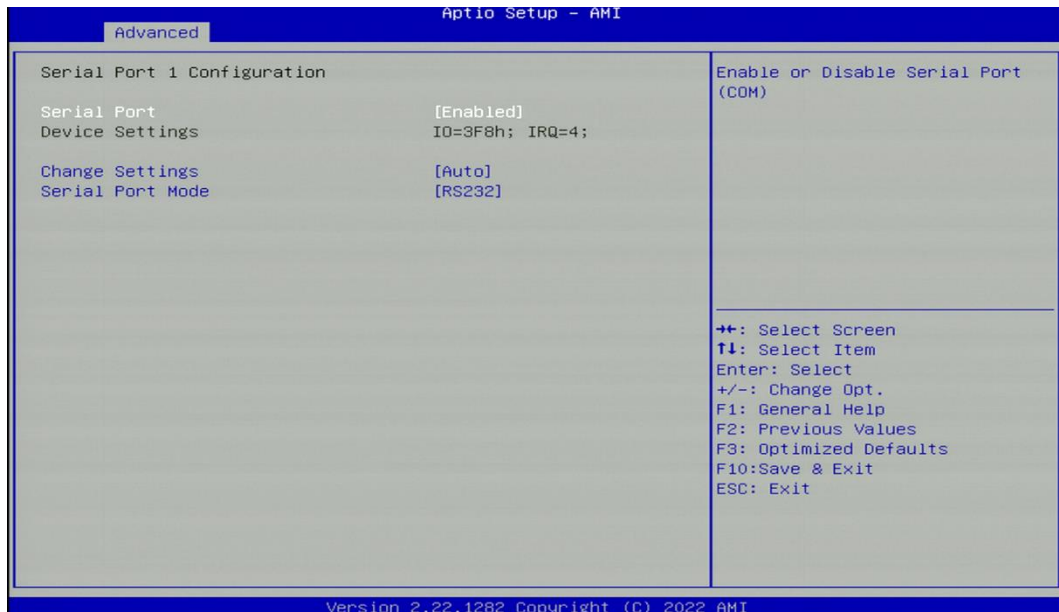

### Serial Port [Enabled]

Enables or disables serial port.

### Change Settings [Auto]

Allows you to change the IO Address & IRQ settings of the specified serial port.

### Serial Port Mode [RS232]

Allows you to select Serial Port Mode.

Configuration options: [RS232] [RS422/RS485 Full Duplex] [RS485 Half Duplex]

## ■ Watch Dog Mode [Sec]

Allows to set watchdog timer unit <Sec> or <Min>.

## ■ Watch Dog Timer [0]

Allows you to set watchdog timer's value in the range of 0 to 255.

### 4.3.7 Hardware Monitor

This screen displays the current status of all monitored hardware devices/components such as voltages, temperatures.

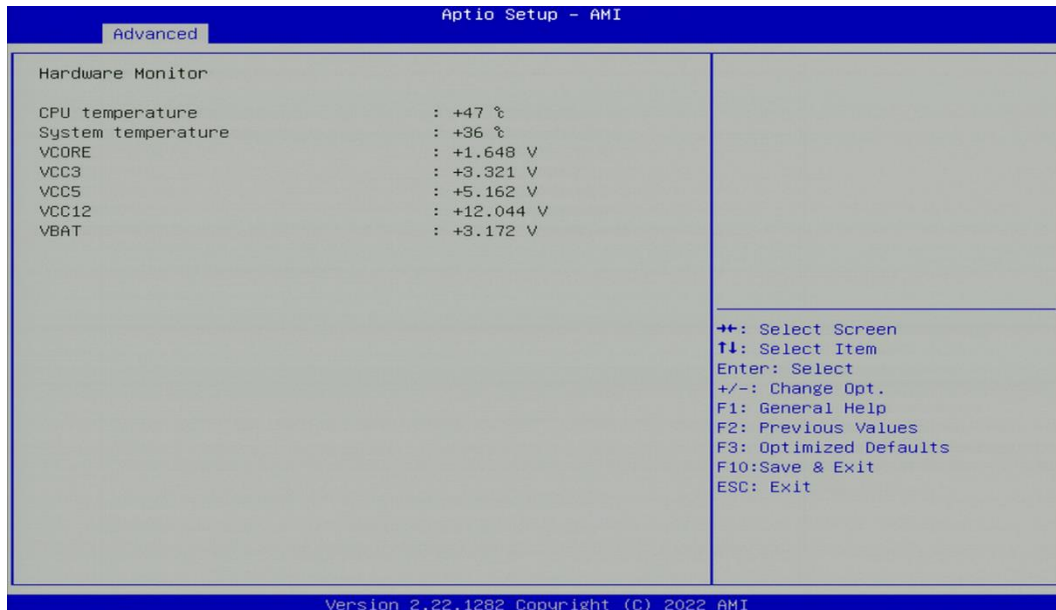

### 4.3.8 S5 RTC Wake Settings



#### ■ Wake system from S5 [Disabled]

Enables or disables wake system from S5 (soft-off state).

[Disabled]: Disables wake system from S5.

[Fixed Time]: Sets a fixed time (HH:MM:SS) to wake system from S5.

[Dynamic Time]: Sets an increase minute(s) from current time to wake system from S5.

### 4.3.9 Serial Port Console Redirection

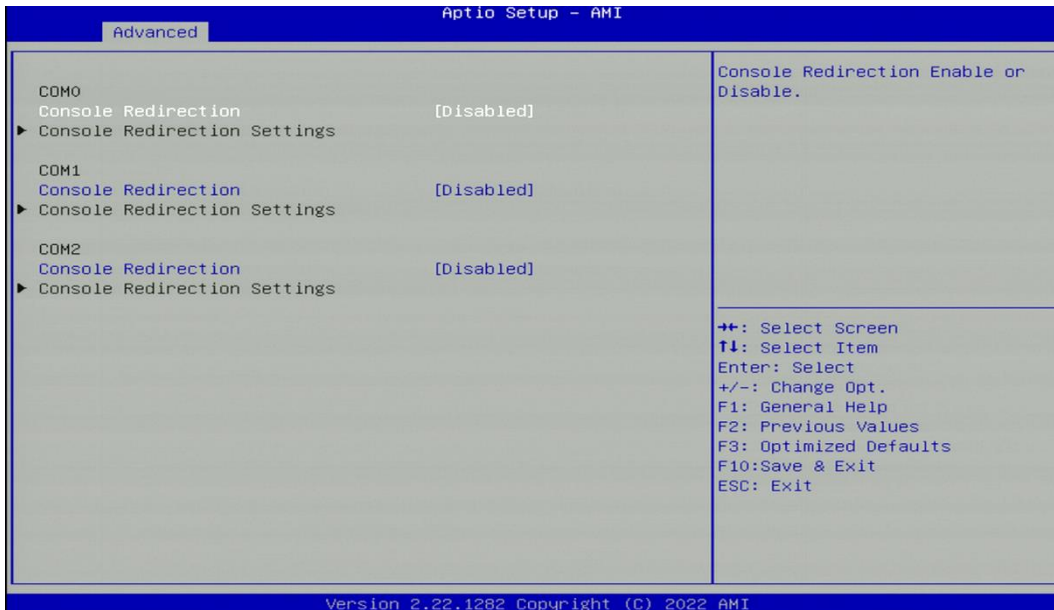

#### ■ Console Redirection [Disabled]

Allow users to enable or disable COM1, COM2, COM3 console redirection function.

### 4.3.10 USB Configuration

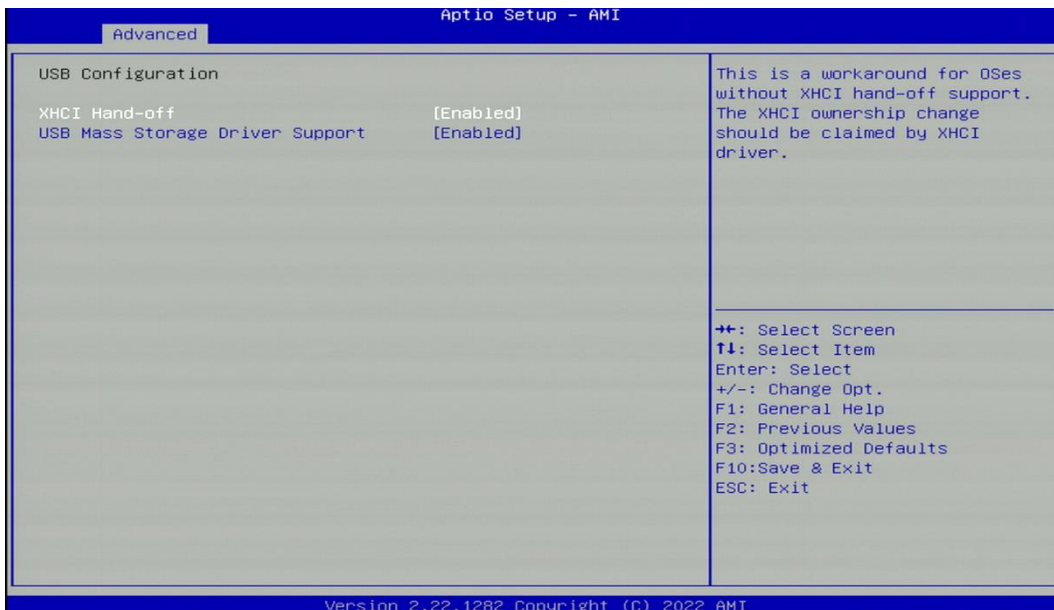

#### ■ XHCI Hand-off [Enabled]

Enables or disables XHCI (USB3.0) hand-off function. Use this feature as a workaround for operating systems without XHCI hand-off support.

#### ■ USB Mass Storage Driver Support [Enabled]

Enables or disables USB mass storage driver support.

### 4.3.11 Network Stack Configuration



#### ■ Network Stack [Disabled]

Enables or disables UEFI Network Stack.

## 4.4 Chipset Setup

This section allows you to configure chipset related settings according to user's preference.

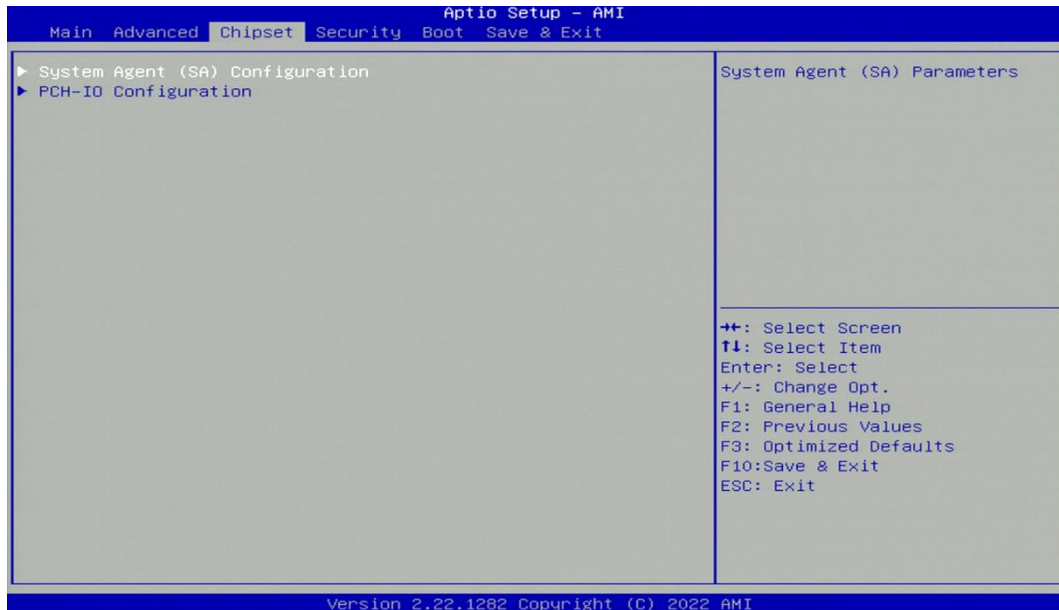

### 4.4.1 System Agent (SA) Configuration

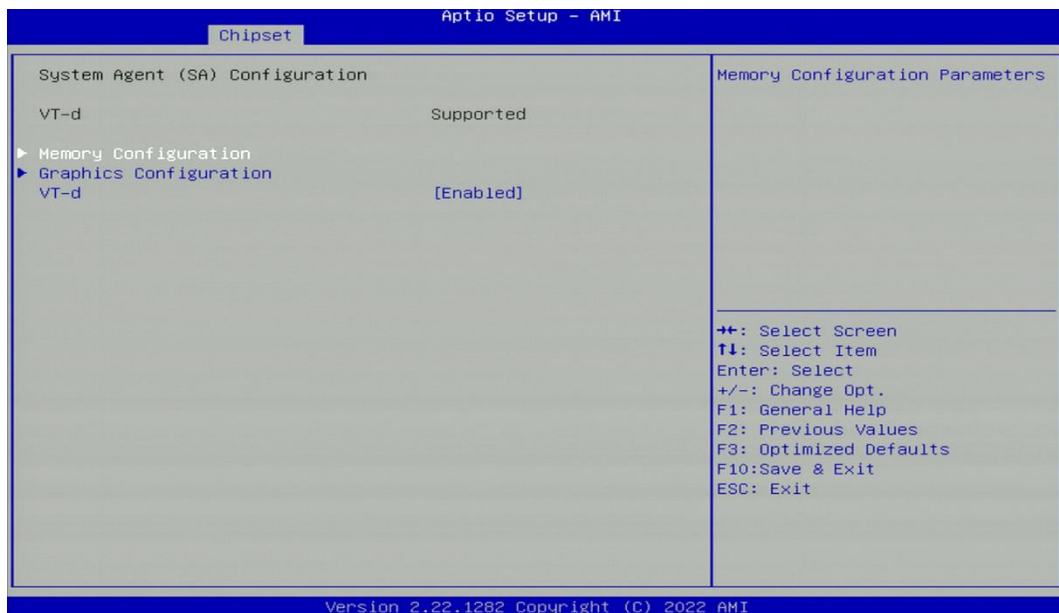

#### ■ Memory Configuration

This item displays detailed memory configuration in the system.

#### ■ Graphics Configuration

##### Primary Display [Auto]

Allows users to enable or disable Primary Display  
Configuration options: [Auto] [IGFX] [PCIe]

##### Internal Graphics [Auto]

Allows users to enable or disable Internal Graphics.  
Configuration options: [Auto] [Disabled] [Enabled]

#### ■ VT-d [Enabled]

Enables or disables Intel® Virtualization Technology for Directed I/O (VT-d) capability.

#### 4.4.2 PCH-IO Configuration

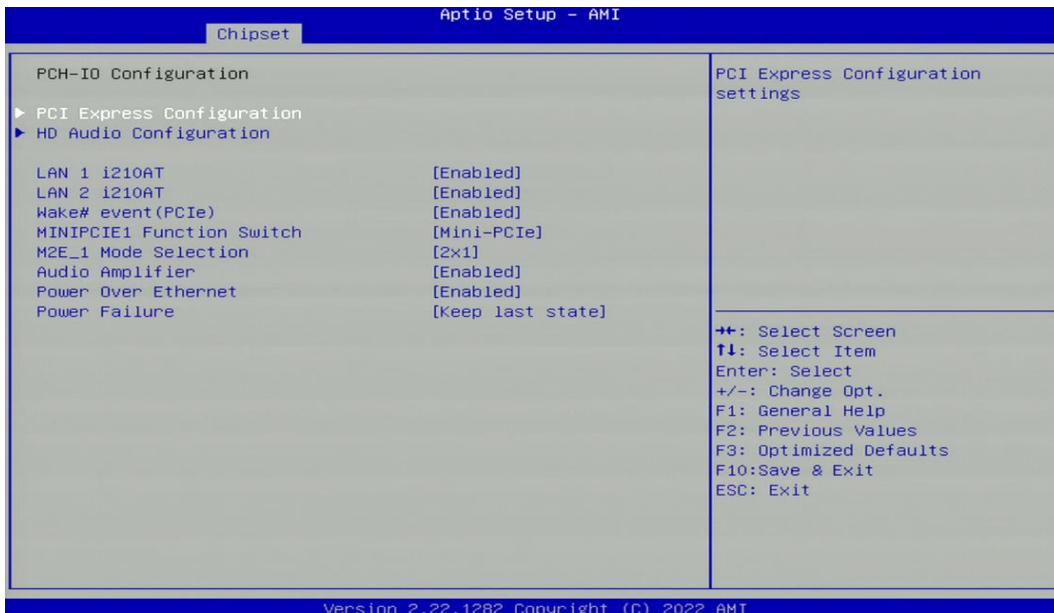

#### ■ PCI Express Configuration



#### □ PCI Express Root Port (MINIPCI1)

##### ■ PCI Express Root Port [Enabled]

Enables or disables PCI Express Root Port.

##### ■ PCIe Speed [Auto]

Allows you to select PCI Express interface speed.

Configuration options: [Auto] [Gen1] [Gen2] [Gen3].

#### □ PCI Express Root Port (M2E\_1)

##### ■ PCI Express Root Port [Enabled]

Enables or disables PCI Express Root Port.

##### ■ PCIe Speed [Auto]

Allows you to select PCI Express interface speed.

Configuration options: [Auto] [Gen1] [Gen2] [Gen3].

**PCI Express Root Port (M2E\_1 2X1)**

■ **PCI Express Root Port [Enabled]**

Enables or disables PCI Express Root Port.

■ **PCIe Speed [Auto]**

Allows you to select PCI Express interface speed.

Configuration options: [Auto] [Gen1] [Gen2] [Gen3].

■ **LAN 1 i210AT Controller [Enabled]**

Enables or disables I210 LAN Controller.

■ **LAN 2 i210AT Controller [Enabled]**

Enables or disables I210 LAN Controller.

■ **Wake# event (PCIe) [Enabled]**

Enables or disables Wake# event (PCIe).

■ **MINIPCI1 Function Switch [Mini-PCIe]**

Allows you to change **MINIPCI1** as [Mini-PCIe] or [mSATA] or [USB3.0].

■ **M2E\_1 Mode Selection [2X1]**

Allows you to select **M2E\_1** mode as [2X1] or [1X2].

■ **Audio Amplifier [Enabled]**

Enables or disables Audio Amplifier Function.

■ **Power Over Ethernet [Enabled]**

Enables or disables Power Over Ethernet Function.

■ **Power Failure [Keep last state]**

Allows you to specify which power state system will enter when power is resumed after a power failure (G3 state).

[Always on]: Enters to power on state.

[Always off]: Enters to power off state.

[Keep last state]: Enters to the last power state before a power failure.

## 4.5 Security Setup

This section allows users to configure BIOS security settings.

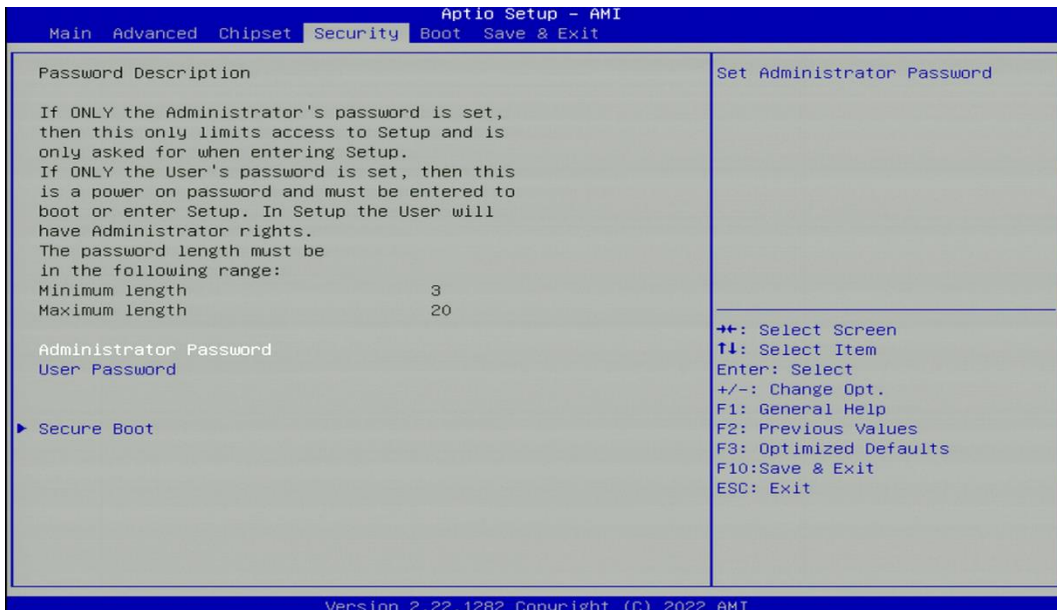

### ■ Administrator Password

Administrator Password controls access to the BIOS Setup utility.

### ■ User Password

User Password controls access to the system at boot and to the BIOS Setup utility.

### ■ Security Boot

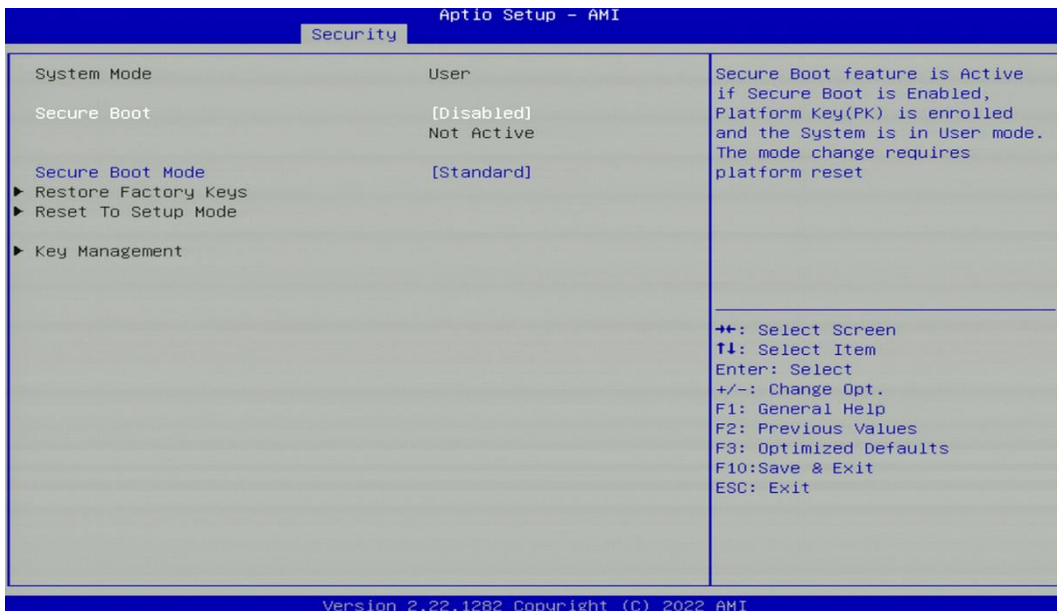

#### Secure Boot [Disabled]

Enable or disable Secure Boot function.

#### Secure Boot Mode [Standard]

Allows you to select Secure Boot Mode.

Configuration options: [Standard] [Custom].



## 4.6 Boot Setup

This section allows you to configure Boot settings.

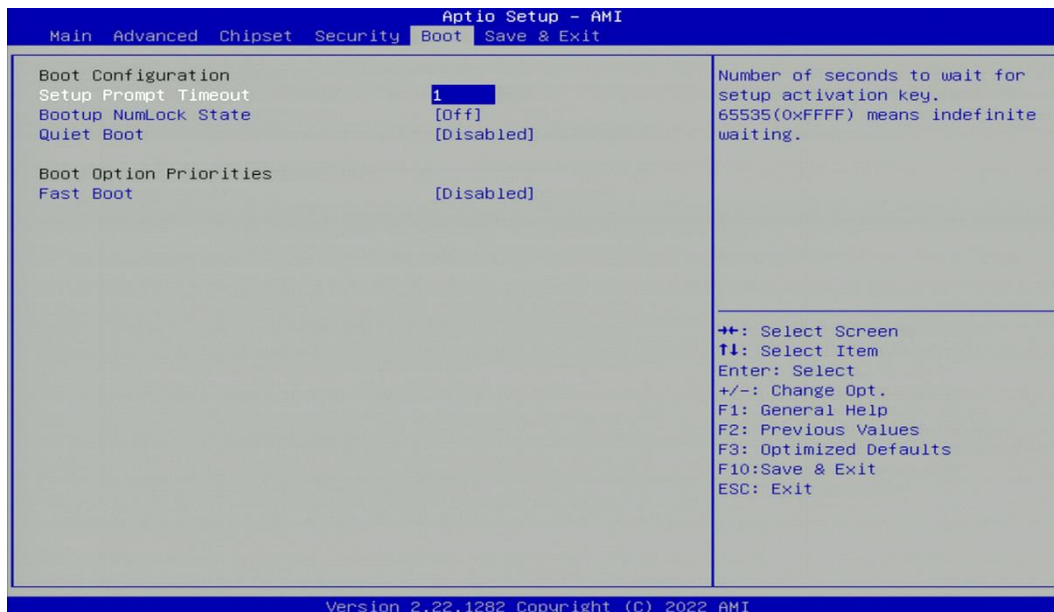

### ■ Setup Prompt Timeout [1]

Use this item to set number of seconds (1..65535) to wait for setup activation key.

### ■ Bootup NumLock State

Allows you to set NumLock key to [On] or [Off] state when system boots up.

### ■ Quiet Boot

Allows you to enable or disable Quiet Boot function.

### ■ Fast Boot

Allows you to enable or disable Fast Boot function. If enabled, system boots with initialization of a minimal set of devices required to launch active boot option.

## 4.7 Save & Exit

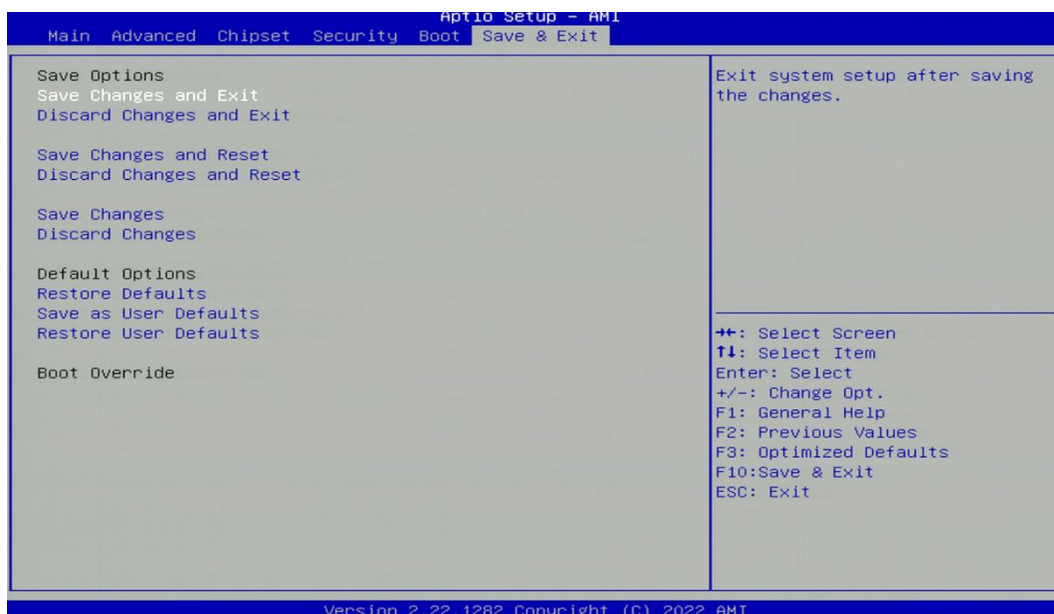

### ■ Save Changes and Exit

This item allows you to exit the system after saving changes.

### ■ Discard Changes and Exit

This item allows you to exit system setup without saving any changes.

### ■ Save Changes and Reset

This item allows you to reset the system after saving changes.

### ■ Discard Changes and Reset

This item allows you to reset system setup without saving any changes.

### ■ Save Changes

This item allows you to save changes.

### ■ Discard Changes

This item allows you to discard changes.

### ■ Restore Defaults

This item allows you to restore/ load default values for all the setup options.

### ■ Save as User Defaults

This item allows you to save the changes done so far as user defaults.

### ■ Restore User Defaults

This item allows you to restore the user defaults to all the setup options.



# **Chapter 5**

## **Product Application**

## 5.1 Digital I/O (DIO) application

This section describes DIO application of the product. The content and application development are better understood and implemented by well experienced professionals or developers.

### 5.1.1 Digital I/O Programming Guide

#### 5.1.1.1 Pins for Digital I/O 1~8

Item	Standard
GPIO 74 (PIN 107)	DI
GPIO 75 (PIN 108)	
GPIO 76 (PIN 109)	
GPIO 77 (PIN 110)	
GPIO 80 (PIN 111)	DO
GPIO 81 (PIN 112)	
GPIO 82 (PIN 113)	
GPIO 83 (PIN 114)	

#### 5.1.1.2 Programming Guide

To program the Super I/O chip **F81966D** configuration registers, the following configuration procedures must be followed in sequence:

- (1) Enter the Extended Function Mode
- (2) Configure the configuration registers
- (3) Exit the Extended Function Mode

The configuration register is used to control the behavior of the corresponding devices. To configure the register, using the index port to select the index and then write data port to alter the parameters. The default index port and data port are 0x4E and 0x4F respectively. To enable configuration, the entry key 0x87 must be written to the index port. To disable configuration, write exit key 0xAA to the index port. Following is an example to enable configuration and to disable configuration by using debug.

- o 4E 87
- o 4E 87 (enable configuration)
- o 4E AA (disable configuration)

#### 5.1.1.3 Relative Registers

To program the **F81966D** configuration registers, see the following configuration procedures.

### Base Address High Register — Index 60h

Bit	Name	R/W	Reset	Default	Description
7-0	BASE_ADDR_HI	R/W	LRESET#	00h	The MSB of WDT base address.

### Base Address Low Register — Index 61h

Bit	Name	R/W	Reset	Default	Description
7-0	BASE_ADDR_LO	R/W	LRESET#	00h	The LSB of WDT base address.

### GPIO Access Method

There are nine sets of GPIO which can be accessed by three ways as below:

1. Configuration register port: Use 0x4E/0x4F (or 0x2E/0x2F) port with logic device number 0x06. Please refer to configuration register for detail.
2. Index/Data port: The index port is base address + 0 and data port is base address + 1. To access the GPIO register, user should first write index to index port and then read/write from/to data port. The index for each register is same as the definition in configuration register.
3. Digital I/O: This way could access GPIO data register only. It is used for quickly control the GPIO pins. The register for each address is as below table:

GPIO Digital I/O Registers									
Offset	Register Name	Default Value							
		MSB				LSB			
0h	Index Port	1	1	1	1	1	1	1	1
1h	Data Port	-	-	-	-	-	-	-	-
2h	GPIO8 Data Port	-	-	-	-	-	-	-	-
3h	GPIO7 Data Port	-	-	-	-	-	-	-	-
4h	GPIO6 Data Port	-	-	-	-	-	-	-	-
5h	GPIO5 Data Port	-	-	-	-	-	-	-	-
6h	GPIO0 Data Port	-	-	-	-	-	-	-	-
7h	GPIO1 Data Port	-	-	-	-	-	-	-	-
8h*	GPIO2 Data Port	-	-	-	-	-	-	-	-
9h*	GPIO3 Data Port	-	-	-	-	-	-	-	-
Ah*	GPIO4 Data Port	-	-	-	-	-	-	-	-
Bh*	GPIO9 Data Port	-	-	-	-	-	-	-	-
E-Fh*	Reserved	-	-	-	-	-	-	-	-

\*Available when GPIO\_DEC\_RANGE is set "1" (Configuration register index 0x27, bit 5)

## GPIO access way by Digital I/O (Access GPIO data register Only)

GPIO8 Data Port — Index 02h

Bit	Name	R/W	Reset	Default	Description
7-0	GPIO8_DATA	R/W	LRESET#	-	GPIO8 Data Control Write data to this byte will change the value of GPIO80_ DATA ~ GPIO87_ DATA in configuration register as writing data to index 0x89. Read data from this byte will read the pin status of GPIO80_ST ~ GPIO87_ST as the value in index 0x8A

GPIO7 Data Port — Index 03h

Bit	Name	R/W	Reset	Default	Description
7-0	GPIO7_DATA	R/W	LRESET#	-	GPIO7 Data Control Write data to this byte will change the value of GPIO70_ DATA ~ GPIO77_ DATA in configuration register as writing data to index 0x81. Read data from this byte will read the pin status of GPIO70_ST ~ GPIO77_ST as the value in index 0x82

## GPIO access way by Configuration register port (Access 0x4E/0x4F port with device number 0x06)

Logic Device Number Register (LDN) — Index 07h

Bit	Name	R/W	Reset	Default	Description
7-0	LDN	R/W	LRESET#	00h	03h: Select Parallel Port device configuration registers. 04h: Select Hardware Monitor device configuration registers. 05h: Select KBC device configuration registers. 06h: Select GPIO device configuration registers. 07h: Select WDT device configuration registers. 0Ah: Select PME, ACPI and ERP device configuration registers. 0Fh: Select SPI device configuration registers. 10h: Select UART1 device configuration registers. 11h: Select UART2 device configuration registers. 12h: Select UART3 device configuration registers. 13h: Select UART4 device configuration registers. 14h: Select UART5 device configuration registers. 15h: Select UART6 device configuration registers. Otherwise: Reserved.

GPIO7x Output Enable Register — Index 80h

Bit	Name	R/W	Reset	Default	Description
7	GPIO77_OE	R/W	3VCC	0	0: GPIO77 is in input mode. 1: GPIO77 is in output mode.
6	GPIO76_OE	R/W	3VCC	0	0: GPIO76 is in input mode. 1: GPIO75 is in output mode.
5	GPIO75_OE	R/W	3VCC	0	0: GPIO75 is in input mode. 1: GPIO75 is in output mode.
4	GPIO74_OE	R/W	3VCC	0	0: GPIO74 is in input mode. 1: GPIO74 is in output mode.

**GPIO7x Pin Status Register — Index 82h (This byte could be also read by base address + 3)**

Bit	Name	R/W	Reset	Default	Description
7	GPIO77_ST	R	-	-	The pin status of GPIO77.
6	GPIO76_ST	R	-	-	The pin status of GPIO76.
5	GPIO75_ST	R	-	-	The pin status of GPIO75.
4	GPIO74_ST	R	-	-	The pin status of GPIO74.

**GPIO8x Output Enable Register — Index 88h**

Bit	Name	R/W	Reset	Default	Description
3	GPIO83_OE	R/W	3VCC	0	0: GPIO83 is in input mode. 1: GPIO83 is in output mode.
2	GPIO82_OE	R/W	3VCC	0	0: GPIO82 is in input mode. 1: GPIO82 is in output mode.
1	GPIO81_OE	R/W	3VCC	0	0: GPIO81 is in input mode. 1: GPIO81 is in output mode.
0	GPIO80_OE	R/W	3VCC	0	0: GPIO80 is in input mode. 1: GPIO80 is in output mode.

**GPIO8x Output Data Register — Index 89h (This byte could be also written by base address + 2)**

Bit	Name	R/W	Reset	Default	Description
3	GPIO83_DATA	R/W	3VCC	1	0: GPIO83 outputs 0 when in output mode. 1: GPIO83 outputs 1 when in output mode.
2	GPIO82_DATA	R/W	3VCC	1	0: GPIO82 outputs 0 when in output mode. 1: GPIO82 outputs 1 when in output mode.
1	GPIO81_DATA	R/W	3VCC	1	0: GPIO81 outputs 0 when in output mode. 1: GPIO81 outputs 1 when in output mode.
0	GPIO80_DATA	R/W	3VCC	1	0: GPIO80 outputs 0 when in output mode. 1: GPIO80 outputs 1 when in output mode.

#### 5.1.1.4 Sample Code in C Language

This sample code is demonstrate how to access GPIO by the way of Configuration Register port.

##### 5.1.1.4.1 Control of GP74 to GP77 (DI1~DI4)

```
#define AddrPort 0x4E
#define DataPort 0x4F

<Enter the Extended Function Mode>
WriteByte(AddrPort, 0x87)
WriteByte(AddrPort, 0x87) // Must write twice to enter extended mode

<Select Logic Device>
WriteByte(AddrPort, 0x07)
WriteByte(dataPort, 0x06) // Select logic device 06h

<Output/Input Mode Selection> // Set GP74 to GP77 input mode
WriteByte(AddrPort, 0x80) // Select configuration register 80h
WriteByte(DataPort, 0x0X) // Set bit 4~7 = 0 to select GP 74~77 as input mode.

<Input Value>
WriteByte(AddrPort, 0x82) // Select configuration register 82h
ReadByte(DataPort, Value) // If read bit 4~7 as 0xFF, thus GP74~77 is all high.
// If read bit 4~7 as 0x0X, thus GP74~77 is all low.

<Leave the Extended Function Mode>
WriteByte(AddrPort, 0xAA)
```

##### 5.1.1.4.2 Control of GP80 to GP83 (DO1~DO4)

```
#define AddrPort 0x4E
#define DataPort 0x4F

<Enter the Extended Function Mode>
WriteByte(AddrPort, 0x87)
WriteByte(AddrPort, 0x87) // Must write twice to enter extended mode

<Select Logic Device>
WriteByte(AddrPort, 0x07)
WriteByte(DataPort, 0x06) // Select logic device 06h

<Output/Input Mode Selection> // Set GP80 to GP83 output mode
WriteByte(AddrPort, 0x88) // Select configuration register 88h
```



```
WriteByte(DataPort, 0xFF) // Set bit 0~3 = 1 to select GP 80~83 as output mode
```

<Output Value>

```
WriteByte(AddrPort, 0x89) // Select configuration register 89h
```

```
WriteByte(DataPort, Value) // Set bit 0~3 = (0 or 1) to output GP 80~83 as low or High
```

<Leave the Extended Function Mode>

```
WriteByte(AddrPort, 0xAA)
```

#### 5.1.1.5 Change base address

<Enter the Extended Function Mode>

```
WriteByte(AddrPort, 0x87)
```

```
WriteByte(AddrPort, 0x87) // Must write twice to enter Extended mode
```

<Select Logic Device>

```
WriteByte(AddrPort, 0x07)
```

```
WriteByte(dataPort, 0x06) // Select logic device 06h
```

```
WriteByte(AddrPort, 0x60) // Select configuration register 60h (High Byte address)
```

```
WriteByte(DataPort, (0x0A))
```

```
WriteByte(AddrPort, 0x61) // Select configuration register 61h (Low Byte address)
```

```
WriteByte(DataPort, (0x00))
```

<Leave the Extended Function Mode>

```
WriteByte(AddrPort, 0xAA)
```

**Note:** Cincoze default DIO Port base address is 0xA00h

### 5.1.1.6 DATA Bit Table (GPIO)

7	6	5	4	3	2	1	0	bit	<b>=DI1</b>	7	6	5	4	3	2	1	0	bit	<b>=DO1</b>
0	0	0	1	-	-	-	-	value	(Base address +3)	-	-	-	-	0	0	0	1	value	(Base address +2)
1				X				/h	(0xA03)	X				1				/h	(0xA02)

7	6	5	4	3	2	1	0	bit	<b>=DI2</b>	7	6	5	4	3	2	1	0	bit	<b>=DO2</b>
0	0	1	0	-	-	-	-	value	(Base address +3)	-	-	-	-	0	0	1	0	value	(Base address +2)
2				X				/h	(0xA03)	X				2				/h	(0xA02)

7	6	5	4	3	2	1	0	bit	<b>=DI3</b>	7	6	5	4	3	2	1	0	bit	<b>=DO3</b>
0	1	0	0	-	-	-	-	value	(Base address +3)	-	-	-	-	0	1	0	0	value	(Base address +2)
4				X				/h	(0xA03)	X				4				/h	(0xA02)

7	6	5	4	3	2	1	0	bit	<b>=DI4</b>	7	6	5	4	3	2	1	0	bit	<b>=DO4</b>
1	0	0	0	-	-	-	-	value	(Base address +3)	-	-	-	-	1	0	0	0	value	(Base address +2)
8				X				/h	(0xA03)	X				8				/h	(0xA02)

### 5.1.1.7 DIO I/O Port Address (Default Address 0xA00)

Pin Definition	DI4	DI3	DI2	DI1	DO4	DO3	DO2	DO1
Data Bits	7	6	5	4	3	2	1	0
DIO Type	Digital Input				Digital Output			
I/O Port Address	0xA03				0xA02			

## 5.2 Digital I/O (DIO) Hardware Specification

- XCOM+: Isolated power in V+
- XCOM-: Isolated power in V-
- Isolated power in DC voltage: 9-30V
- 4x Digital Input (Source Type)
- Input Signal Voltage Level
  - Signal Logic 0: XCOM+ = 9V, Signal Low - V- < 1V  

$$\text{XCOM+} > 9\text{V}, \quad \text{V+} - \text{Signal Low} > 8\text{V}$$
  - Signal Logic 1: > XCOM+ - 3V
- Input Driving Sink Current:
  - Minimal: 1 mA
  - Normal: 5 mA
- 4x Digital Output (Open Drain)
  - DO Signal have to pull up resistor to XCOM+ for external device, the resistance will affect the pull up current
  - Signal High Level: Pull up resistor to XCOM+
  - Signal Low Level: = XCOM-
  - Sink Current: 1A (Max)

### 5.2.1 DIO Connector Definition

#### DIO1: Digital Input / Output Connector

Connector Type: Terminal Block 1X10 10-pin, 3.5mm pitch

Pin	Definition	Pin	Definition
1	XCOM+ (DC INPUT)	6	DO1
2	DI1	7	DO2
3	DI2	8	DO3
4	DI3	9	DO4
5	DI4	10	XCOM- (GND)

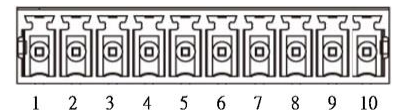

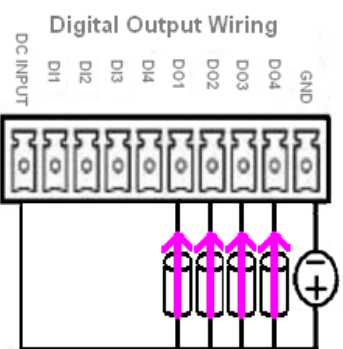
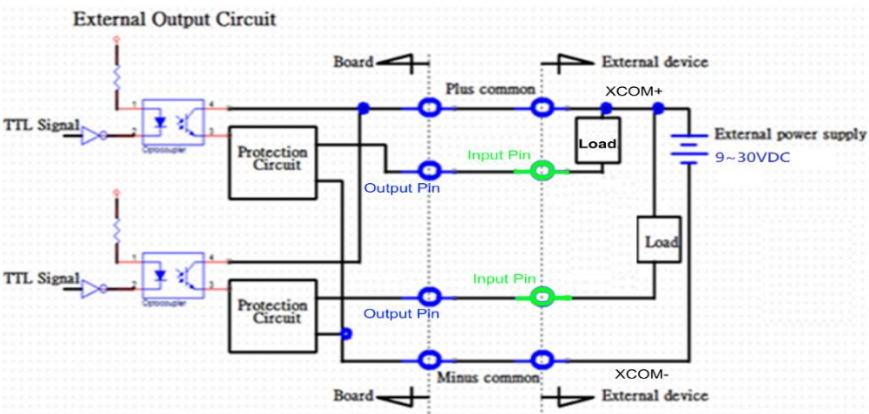
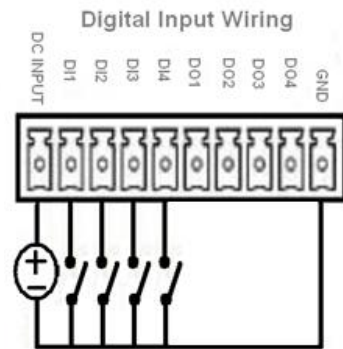
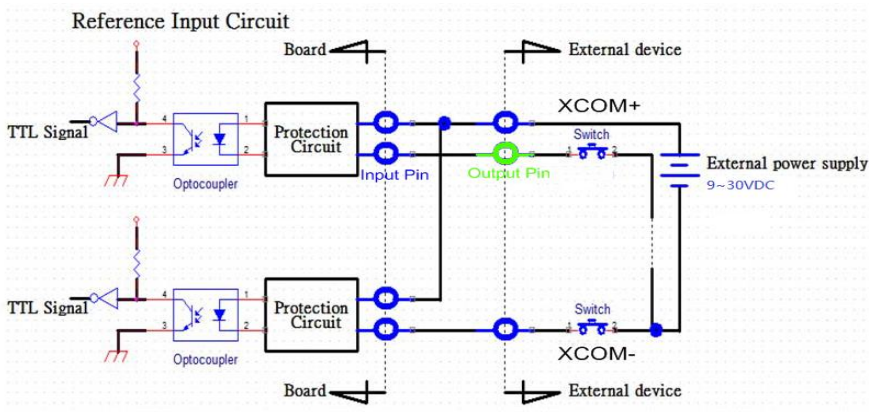



# **Chapter 6**

## **Optional Modules and Accessories**

## 6.1 Pin Definition & Settings

### 6.1.1 CFM-IGN101

#### SW2: IGN Function Switch

Set shutdown delay timer when ACC is turned off

Pin 1	Pin 2	Pin 3	Pin 4	Definition
ON (IGN Enabled) / OFF (IGN Disabled)	ON	ON	ON	0 second
	ON	ON	OFF	1 minute
	ON	OFF	ON	5 minutes
	ON	OFF	OFF	10 minutes
	OFF	ON	ON	30 minutes
	OFF	ON	OFF	1 hour
	OFF	OFF	ON	2 hours
	OFF	OFF	OFF	Reserved (0 second)

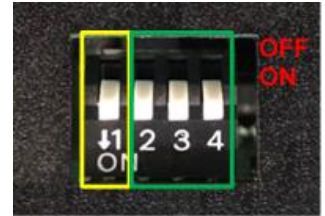

#### 24V\_12V\_1: 12V / 24V Car Battery Switch

Pin	Definition
1-2	24V Car Battery Input (default)
2-3	12V Car Battery Input



## 6.2 Installing CFM Module

### 6.2.1 CFM-IGN101

1. Locate the IGN connector on system motherboard as indicated.

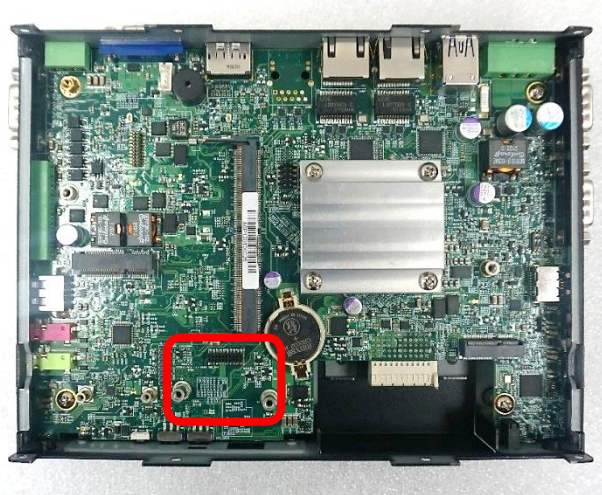

2. Insert CFM-IGN module vertically to the female connector on the system's mainboard, and fasten 2 screws to fix it.



3. Loosen 2 screws on front panel to remove cover plate.



4. IGN function switch is at the front panel of the system.



## 6.2.2 CFM-PoE2

1. Locate the PoE connector on system motherboard as indicated.

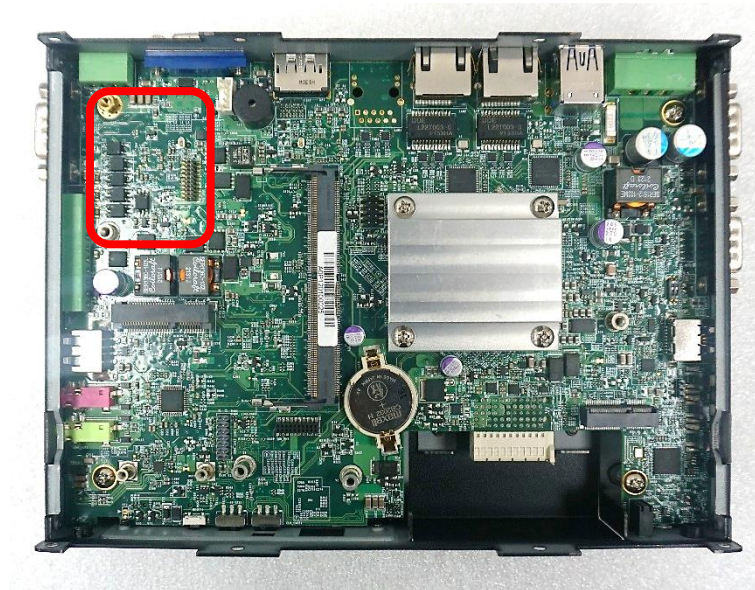

2. Insert the female connector of CFM-PoE module to the male connector on system motherboard.

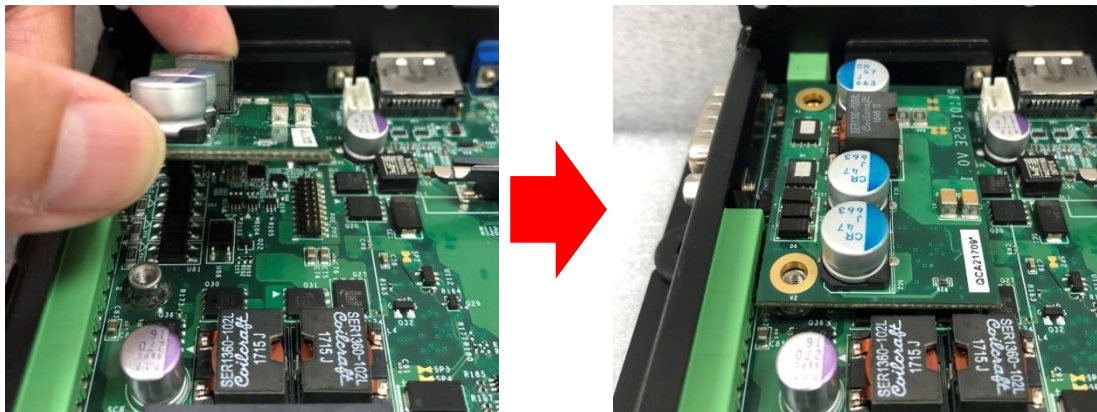

3. Turn over the heatsink and paste the thermal pad onto the marked by red squares.

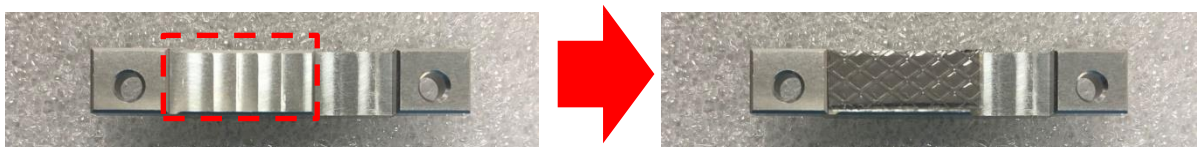

CAUTION  
(ATTENTION)

Before putting on the thermal block (in the next step), please make sure the protective film on the Thermal Pad has been removed!

(Avant de mettre le bloc thermique (à l'étape suivante), veuillez vous assurer que le film protecteur sur le coussin thermique a été retiré!)



4. Paste the heatsink onto the CFM-PoE module carefully and fasten 2 screws to fix it.

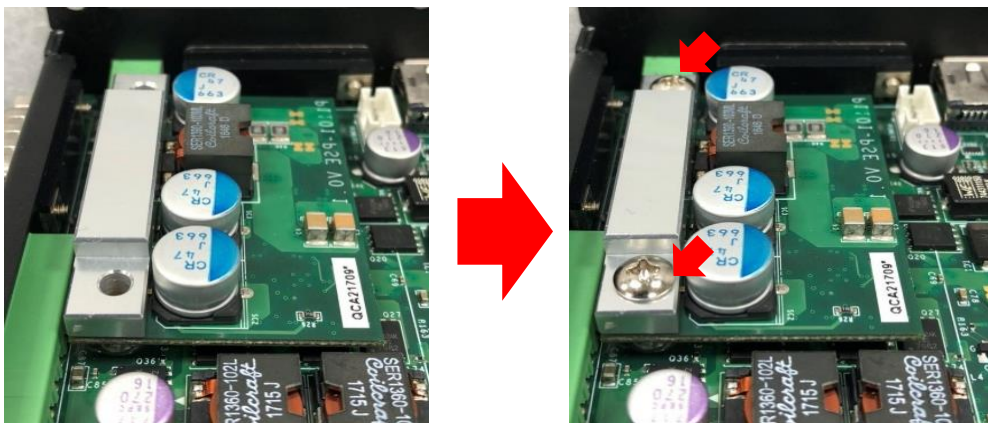

5. Paste the thermal pads onto the heatsink and coil carefully.

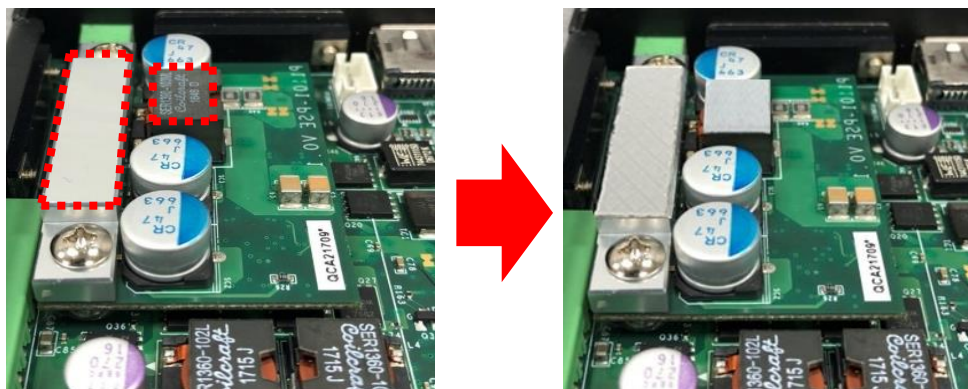

**CAUTION**  
(ATTENTION)

**Before assembling the system's chassis cover, please make sure the protective film on the Thermal Pad has been removed!**  
**(Avant d'assembler le couvercle du châssis du système, assurez-vous que le film protecteur sur le coussin thermique a été retiré !d'alimentation CC au système.)**

6. When the system is power on, please note that the POE LED will light on if the POE module is properly installed.

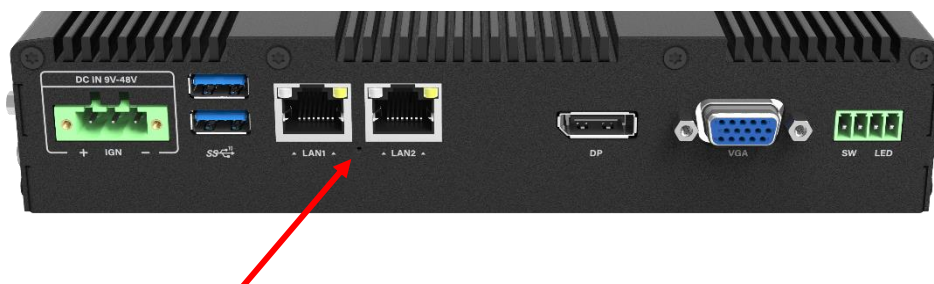

***cincoze***

© 2023 Cincoze Co., Ltd. All rights reserved.

The Cincoze logo is a registered trademark of Cincoze Co., Ltd.

All other logos appearing in this catalog are the intellectual property of the respective company, product, or organization associated with the logo.

All product specifications and information are subject to change without notice.