

CV-110H/P1001 Series

10.4" TFT XGA 4:3 Panel PC, w/ Intel® Atom™ E3845
Quad Core, 4x USB, 2x COM, 1x VGA and 1x DisplayPort



POWER EFFICIENT INDUSTRIAL PANEL PC | CV-100/P1000 Series |

Overview

[CONTACT](#)

The 10.4" all-in-one panel PC offers LED backlight LCD with resolution up to 1024x768 (XGA) and 400 nits brightness. CV-110H/P1001 Series features flat surface and IP65 dust/waterproof front panel. In addition, designed with aluminum die-casting front frame with rugged body structure that can be able to apply in industrial applications. CV-110H/P1001 Series supports Convertible Display System (CDS) technology which makes it more flexible in system maintaining and upgrading. CV-110H/P1001 Series carries single touch function with resistive 5-wire touch screen or multi-touch function with projected capacitive touch screen. By incorporating with Intel® Atom™ E3845 processor and DDR3L memory, CV-110H/P1001 Series offers extensive I/O including 4x USB, 2x RS232/422/485, 1x VGA, 1x DisplayPort and 4 DI/ 4DO. Besides, the panel PC also includes 2x Universal I/O Bracket. (For P1001E only) CV-110H/P1001 Series supports 3G and WLAN via 2x GbE and 1x Mini-PCIe slot. Furthermore, there are 3 types of storage devices including 2.5" SATA HDD, CFast and SIM card. The accessible design of these storage devices allow quick data access and easy maintenance. Supporting wide range power DC input from 9 ~ 48VDC, CV-110H/P1001 Series can be deployed and powered for various industrial applications.

Key Features

- 10.4" TFT XGA 4:3 LCD with Resistive 5-wire / Projected Capacitive Touch
- Designed with Aluminum Die-Casting Front Frame
- Onboard Intel® Atom™ E3845 Processor Quad Core, 1.91GHz
- 1x DDR3L SO-DIMM max. up to 8GB
- 1x 2.5" SATA HDD Bay, 1x CFast Card and 1x SIM Card Socket
- 2x LAN, 4x USB, 2x COM, 1x VGA, 1x DisplayPort, 4x DI/4x DO
- 1x Mini-PCIe Expansion Socket
- IP 65 Compliant Front Panel
- Supports Panel / VESA / Rack Mounting
- Convertible Display System (CDS) Supported
- Built-in Two 2W Internal Speakers
- 2x Universal I/O Brackets(For P1001E only)

Certifications



CV-110H Series Specifications

Model Name	CV-110HR	CV-110HC
Display		
LCD Size	• 10.4" (4:3)	
Max. Resolution	• 1024 x 768	
Brightness (cd/m2)	• 400	
Contrast Ratio	• 1400 : 1	
LCD Color	• 16.2M	
Pixel Pitch (mm)	• 0.2055 (H) x 0.2055 (V)	
Viewing Angle (H-V)	• 178 / 178	
Backlight MTBF	• 50,000 hrs (LED Backlight)	
Touch Screen		
Touch Type	• Resistive 5-wire	• Projected Capacitive
Physical		
Dimension (W x D x H)	• 295 x 227.3 x 56.2 mm	
Weight Information	• 2.24 kg	
Mechanical Construction	• Die-Casting Flat Surface	
Environment		
Front Panel Protection	• IP 65 Compliant	
Operating Temperature	• Ambient with Air flow: -20°C to 75°C (with Industrial Grade Peripherals)	• Ambient with Air Flow: -20°C to 80°C (with Industrial Grade peripherals)
Storage Temperature	• -30°C to 80°C	
Relative Humidity	• 90% RH @ 40°C (Non-condensing)	
EMC	• CE, UKCA, FCC, ICES-003 Class A	
EMI	<ul style="list-style-type: none"> • CISPR 32 Conducted & Radiated: Class A • EN/BS EN 55032 Conducted & Radiated: Class A • EN/BS EN IEC 61000-3-2 Harmonic current emissions: Class A • EN/BS EN61000-3-3 Voltage fluctuations & flicker • FCC 47 CFR Part 15B, ICES-003 Conducted & Radiated: Class A 	
EMS	<ul style="list-style-type: none"> • EN/IEC 61000-4-2 ESD: Contact: 4 kV; Air: 8 kV • EN/IEC 61000-4-3 RS: 80 MHz to 1000 MHz: 3 V/m • EN/IEC 61000-4-4 EFT: AC Power: 1 kV; DC Power: 0.5 kV; Signal: 0.5 kV • EN/IEC 61000-4-5 Surges: AC Power: 2 kV; Signal: 1 kV • EN/IEC 61000-4-6 CS: 3V • EN/IEC 61000-4-8 PFMF: 50 Hz, 1A/m • EN/IEC 61000-4-11 Voltage Dips & Voltage Interruptions: 0.5 cycles at 50 Hz 	
Safety	• UL, cUL, CB, IEC, EN 62368-1	

P1001 Series Specifications

Model Name	P1001	P1001E
System		
Processor	<ul style="list-style-type: none"> Onboard Intel® Atom™ Processor E3845 Quad Core, 1.91 GHz 	
Memory	<ul style="list-style-type: none"> 1x DDR3L 1066/1333 MHz SO-DIMM Socket (un-buffered and non-ECC) Support up to 8 GB 	
BIOS	<ul style="list-style-type: none"> AMI 64Mbit SPI BIOS 	
Graphics		
CDS (Convertible Display System) Technology	<ul style="list-style-type: none"> 1x Convertible Display System (CDS) Interface 	
VGA	<ul style="list-style-type: none"> 1x VGA Connector (1920x1080@60Hz) 	
DP	<ul style="list-style-type: none"> 1x DisplayPort Connector (1920x1080@60Hz) 	
Audio		
Line-out	<ul style="list-style-type: none"> 1x Line-out, Phone Jack 3.5mm 	
Mic-in	<ul style="list-style-type: none"> 1x Mic-in, Phone Jack 3.5mm 	
I/O		
LAN	<ul style="list-style-type: none"> 2x GbE LAN (Supports WoL, Teaming, Jumbo Frame & PXE), RJ45 - GbE1: Intel® I210 - GbE2: Intel® I210 	
USB	<ul style="list-style-type: none"> 1x USB 3.2 Gen1 (Type A), 3x USB 2.0 (Type A) 	
Serial Port	<ul style="list-style-type: none"> 2x RS-232/422/485 with Auto Flow Control Support, DB9 	
DIO	<ul style="list-style-type: none"> 8x Isolated Digital I/O (4in/4out) 	
Storage		
SSD/HDD	<ul style="list-style-type: none"> 1x 2.5" HDD/SSD Drive 	
SIM Card	<ul style="list-style-type: none"> 1x Front Accessible SIM Socket 	
CFast	<ul style="list-style-type: none"> 1x Front Accessible CFast Socket 	
Expansion		
Mini PCI Express	<ul style="list-style-type: none"> 1x Full-size Mini-PCIe Socket for Wi-Fi/GSM/Expansion Module 	
Universal Bracket		<ul style="list-style-type: none"> 2x Universal I/O Bracket
Other Function		
Watchdog Timer	<ul style="list-style-type: none"> Software Programmable Supports 256 Levels System Reset 	
Internal Speaker	<ul style="list-style-type: none"> AMP 2W + 2W 	
OSD Function	<ul style="list-style-type: none"> LCD On/Off, Brightness Up, Brightness Down 	
Reset Button	<ul style="list-style-type: none"> 1x Reset Button 	
Power		
Power Button	<ul style="list-style-type: none"> 1x ATX Power On/Off Switch 	
Power Mode Switch	<ul style="list-style-type: none"> 1x AT/ATX Mode Switch 	
Power Input	<ul style="list-style-type: none"> 1x 3-pin Terminal Block Connector with Power Input 9~48VDC 	
Power Adapter (Optional)	<ul style="list-style-type: none"> 1x Optional AC/DC 12V/5A, 60W 	

Physical		
Dimension (W x D x H)	• 204.5 x 149 x 37.5 mm	• 204.5 x 150 x 60 mm
Weight Information	• 1.34kg	• 1.54kg
Mechanical Construction	• Extruded Aluminum with Heavy Duty Metal	
Mounting	• Wall / VESA / CDS Mounting	
Physical Design	<ul style="list-style-type: none"> • Fanless Design • Jumper-less Design 	
Reliability & Protection		
Reverse Power Input	• Yes	
Over Voltage Protection	<ul style="list-style-type: none"> • Protection Range: 51~58V • Protection Type: shut down operating voltage, re-power on at the present level to recover 	
Over Current Protection	• 20A	
Operating System		
Microsoft® Windows®	<ul style="list-style-type: none"> • Windows® 10, Windows® 8, Windows® 7 • Windows® Embedded 8 Standard, Windows® Embedded Standard 7 	
Linux	• Supports by project	
Environment		
Operating Temperature	• Ambient with Air Flow: -20°C to 70°C (with Industrial Grade Peripherals)	
Storage Temperature	• -30°C to 85°C	
Relative humidity	• 10%~95% RH (Non-condensing)	
Shock	• Operating, 15 Grms, Half-sine 11 ms Duration (w/ SSD, according to IEC60068-2-27)	
Vibration	• Operating, 1 Grms, 5-500 Hz, 3 Axes (w/ SSD, according to IEC60068-2-64)	
EMC	• CE, UKCA, FCC, ICES-003 Class A	
EMI	<ul style="list-style-type: none"> • CISPR 32 Conducted & Radiated: Class A • EN/BS EN 55032 Conducted & Radiated: Class A • EN/BS EN IEC 61000-3-2 Harmonic current emissions: Class A • EN/BS EN61000-3-3 Voltage fluctuations & flicker • FCC 47 CFR Part 15B, ICES-003 Conducted & Radiated: Class A 	
EMS	<ul style="list-style-type: none"> • EN/IEC 61000-4-2 ESD: Contact: 4 kV; Air: 8 kV • EN/IEC 61000-4-3 RS: 80 MHz to 1000 MHz: 3 V/m • EN/IEC 61000-4-4 EFT: AC Power: 1 kV; DC Power: 0.5 kV; Signal: 0.5 kV • EN/IEC 61000-4-5 Surges: AC Power: 2 kV; Signal: 1 kV • EN/IEC 61000-4-6 CS: 3V • EN/IEC 61000-4-8 PFMF: 50 Hz, 1A/m • EN/IEC 61000-4-11 Voltage Dips & Voltage Interruptions: 0.5 cycles at 50 Hz 	

CV-110H/P1001 External Layout

Front I/O

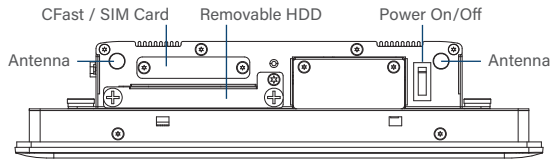

Rear I/O

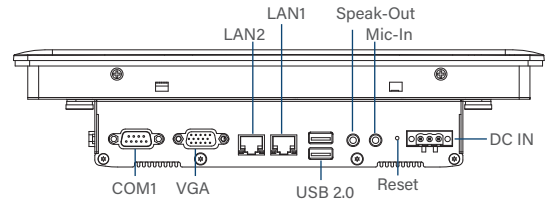

Left I/O

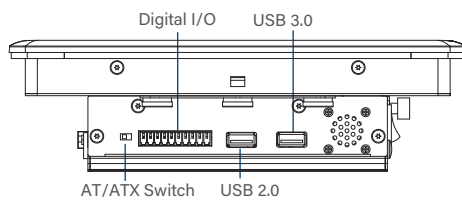

Right I/O

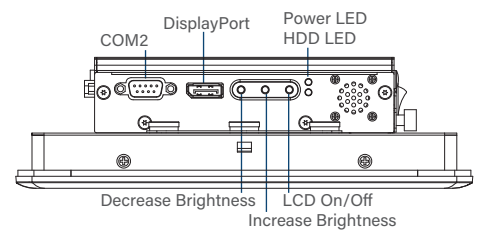

CV-110H/P1001E External Layout

Front I/O

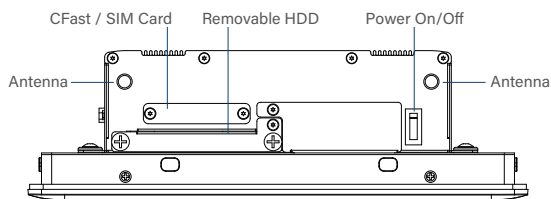

Rear I/O

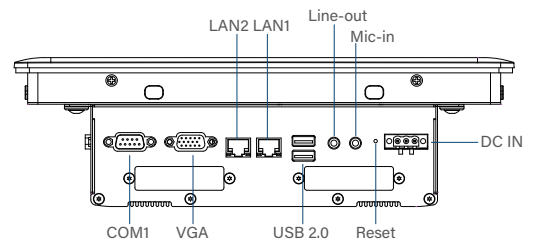

Left I/O

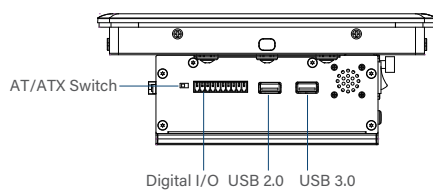

Right I/O

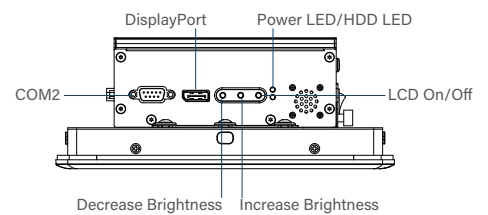

CV-110H/P1001 Dimensions

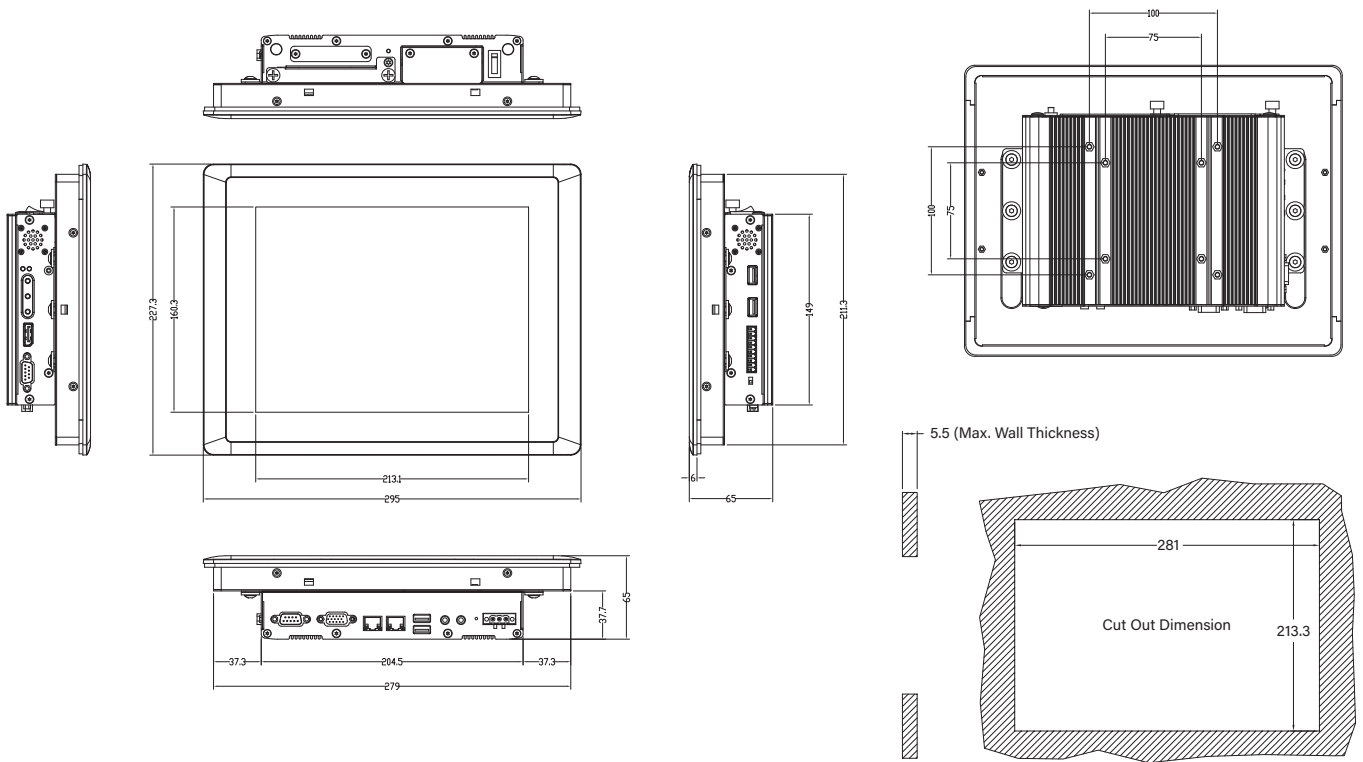

CV-110H/P1001E Dimensions

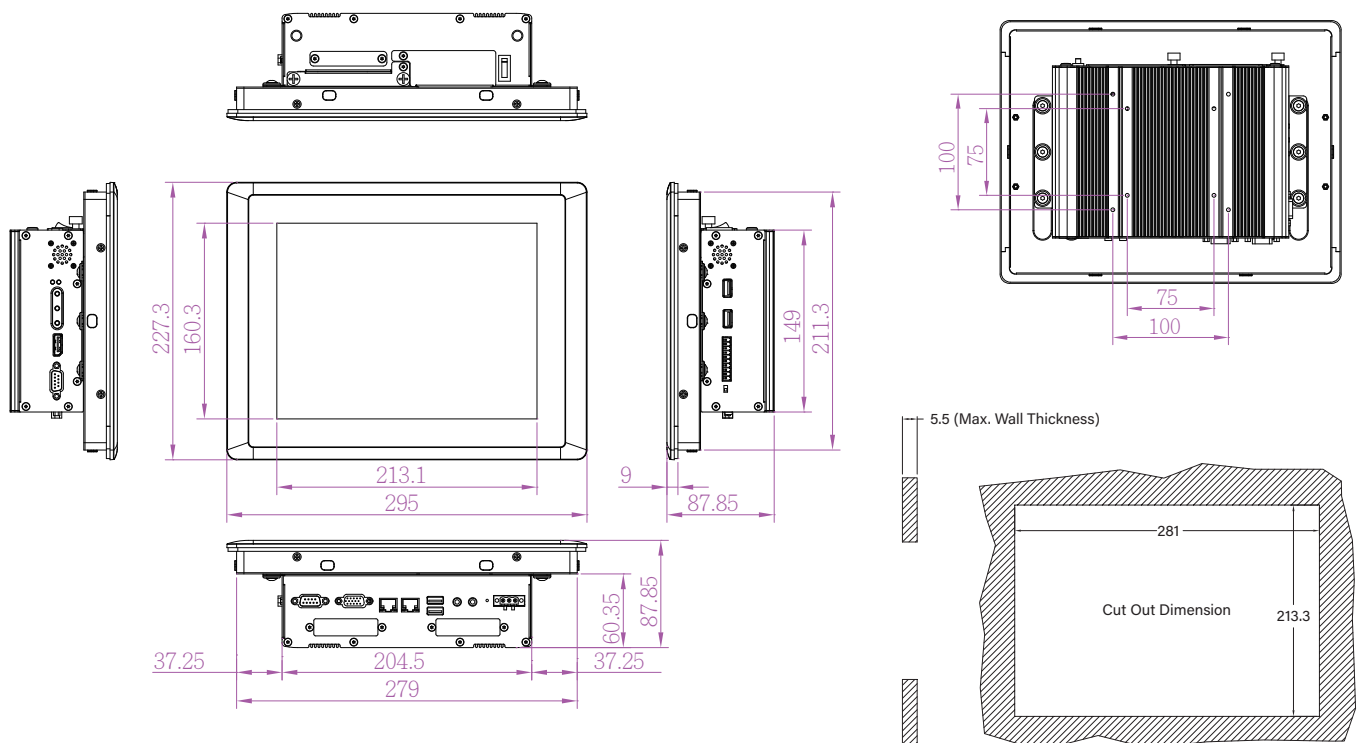

Ordering Information

Available Models

Model No.	Description
CV-110HR-R10/P1001-R10	10.4" TFT SVGA 4:3 Panel PC with Resistive 5-wire Touch, w/ Intel® Atom™ E3845 Quad Core, 4x USB, 2x COM, 1x VGA and 1x DisplayPort
CV-110HC-R11/P1001-R10	10.4" TFT SVGA 4:3 Panel PC with Projected Capacitive Touch, w/ Intel® Atom™ E3845 Quad Core, 4x USB, 2x COM, 1x VGA and 1x DisplayPort
CV-110HR-R10/P1001E-R10	10.4" TFT SVGA 4:3 Panel PC with Resistive 5-wire Touch, with Intel® Atom™ E3845 Quad Core, 4x USB, 2x COM, 1x VGA, 1x DisplayPort and 2x Universal I/O Bracket
CV-110HC-R11/P1001E-R10	10.4" TFT SVGA 4:3 Panel PC with Projected Capacitive Touch, with Intel® Atom™ E3845 Quad Core, 4x USB, 2x COM, 1x VGA, 1x DisplayPort and 2x Universal I/O Bracket

Model Configuration

	CV-110HR	CV-110HC	P1001	P1001E
CV-110HR/P1001	V	--	V	--
CV-110HC/P1001	--	V	V	--
CV-110HR/P1001E	V	--	--	V
CV-110HC/P1001E	--	V	--	V

V : Compatible

Package Checklist



• CV-110H/P1001 Series Panel PC x 1	• Power Terminal Block Connector (Female) x 1
• Panel Mounting Kit x 1	• Screw Pack x 1
• DIO Terminal Block Connector (Female) x 1	

Optional Modules and Accessories

Model No.	Description
MEC-COM-M212-DB9	Mini-PCIe Module with 2x COM Ports, 1x Standard DB9 Cable (For P1001E only)
MEC-LAN-M102-30	Mini-PCIe Module with 2x LAN Ports, 2x 30cm cable (For P1001E only)
MEC-USB-M102-30	Mini-PCIe Module with 2x USB 3.2 Gen1 Ports, 1x 30cm cable (For P1001E only)
UB0303	2x Universal Bracket each with 1x DB9 Cutout (For P1001E only)
UB0311	1x Universal Bracket with 2x RJ45 Cutout (For P1001E only)
UB0314	1x Universal Bracket with 2x USB Cutout (For P1001E only)
URM01	Universal 19" Rack Mount Kit for Industrial Panel PC & Industrial Monitor
GST60A12-CIN1	Adapter AC/DC 12V 5A 60W, GST60A12-CIN1, wide temp (-30°C ~ +70°C)
SL2-SL3	US 2 heads power cord, US B type to IEC C13, SVT 18AWG/3C Black 1.8M SL-2+SL-3
SL6-SL3	EU 2 heads power cord, EU G type to IEC C13, H05VV-F 0.75mm2/3G Black 1.8M SL-6+SL-3
QP026-SL3	UK 2 heads power cord, UK I type to IEC C13, H05VV-F 0.75mm2/3G Black 1.8M QP026+SL-3

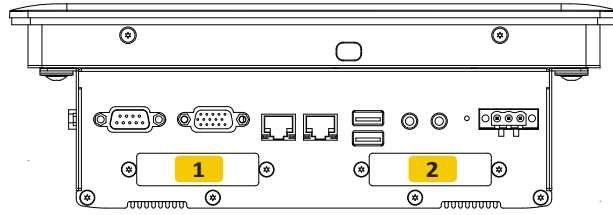
Optional Module Configuration (For P1001E only)

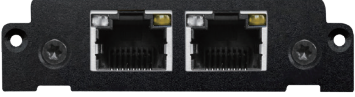

Model No.	Description	1	2
 <p>MEC-COM-M212-DB9/UB0303</p>	Mini-PCIe Module with 2x COM Ports, 1x Standard DB9 Cable, 2x Universal Bracket each with 1x DB9 Cutout	V	V
 <p>MEC-LAN-M102-30/UB0311</p>	Mini-PCIe Module with 2x LAN Ports, 2x 30cm cable, w/ 1x Universal Bracket with 2x RJ45 Cutout	V	V
 <p>MEC-USB-M102-30/UB0314</p>	Mini-PCIe Module with 2x USB 3.2 Gen1 Ports, 1x 30cm cable, 1x Universal Bracket with 2x USB Cutout	V	V

V : Compatible